

Inductors for power circuits

Wound metal

SPM-LR series



SPM3012-LR type



FEATURES

- Magnetic shield type wound inductor for power circuits using a metallic magnetic material.
- Low-profile product.
- Compared to ferrite wound type inductors, it is possible to achieve large current, low Rdc, and compactness.
- Low inductance variance in high-temperature environments with good DC superimposition characteristics.
- Metallic magnetic material is used, and the structure has an integrated molded coil, so hum noise is lower than with core adhesive coils.
- Operating temperature range: -40 to +125°C(including self-heating)

APPLICATION

- Tablet terminals, note PCs, HDDs, servers, VRMs, compact power supply modules, other

PART NUMBER CONSTRUCTION

SPM	3012	T	-	1R0	M	-	LR
Series name	L x W x H dimensions 3.2 x 3.0 x 1.2 mm	Packaging style		Inductance (μH)	Inductance tolerance		Internal code

CHARACTERISTICS SPECIFICATION TABLE

L	Measuring frequency		DC resistance		Rated current *		Part No.
	(μH)	Tolerance	(kHz)	(mΩ)max.	(mΩ)typ.	Isat (A)typ.	
0.47	±20%	100	34.8	31.6	7.3	4.5	SPM3012T-R47M-LR
1.0	±20%	100	59.4	54.0	5.0	3.4	SPM3012T-1R0M-LR
1.5	±20%	100	81.4	74.0	4.3	2.9	SPM3012T-1R5M-LR
2.2	±20%	100	102.3	93.0	3.7	2.6	SPM3012T-2R2M-LR
3.3	±20%	100	195.2	177.4	2.7	1.8	SPM3012T-3R3M-LR
4.7	±20%	100	266.3	231.5	2.3	1.7	SPM3012T-4R7M-LR

* Rated current: smaller value of either Isat or Itemp.

Isat: When based on the inductance change rate (30% below the initial value)

Itemp: When based on the temperature increase (temperature increase of 40°C by self heating)

- The cleaning agent can not be used for these products.

Measurement equipment

Measurement item	Product No. *	Manufacturer
L	4284A	Keysight Technologies
DC resistance	AX-111A	ADEX
Rated current Isat	4284A+42841A+42842C	Keysight Technologies

* Equivalent measurement equipment may be used.

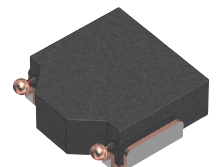

SPM3012-LR type

L FREQUENCY CHARACTERISTICS

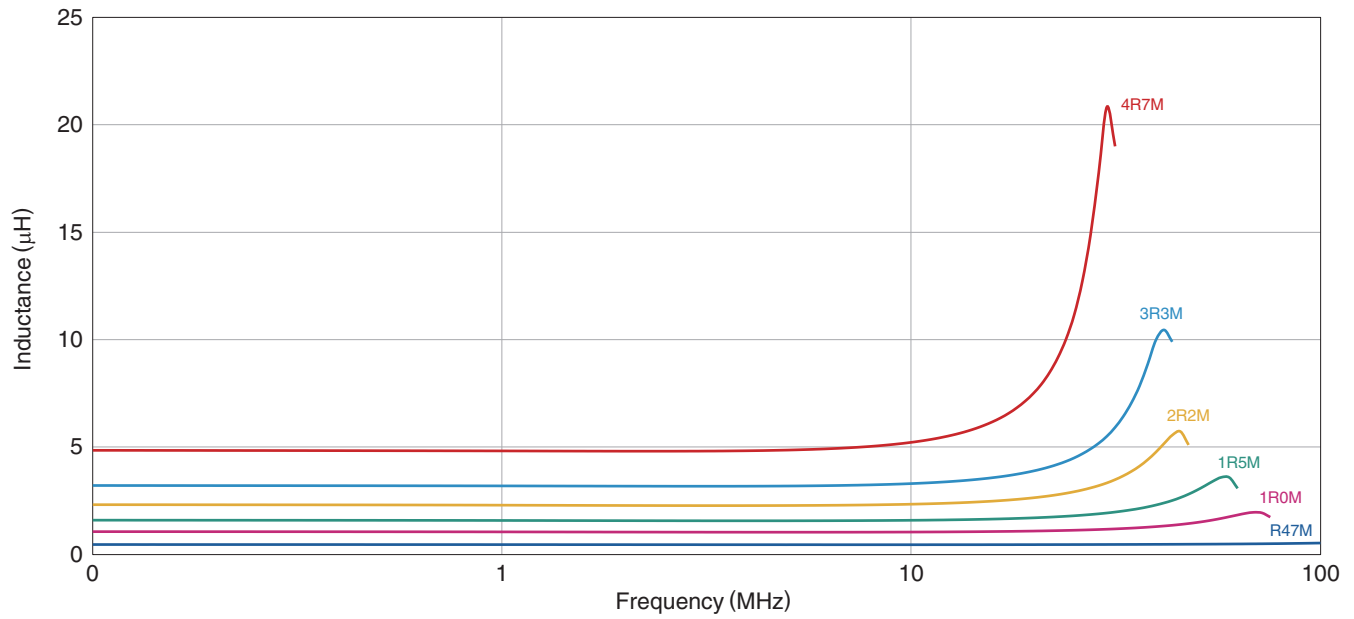

Measurement equipment

Product No. *	Manufacturer
4294A	Keysight Technologies

* Equivalent measurement equipment may be used.

INDUCTANCE VS. DC BIAS CHARACTERISTICS

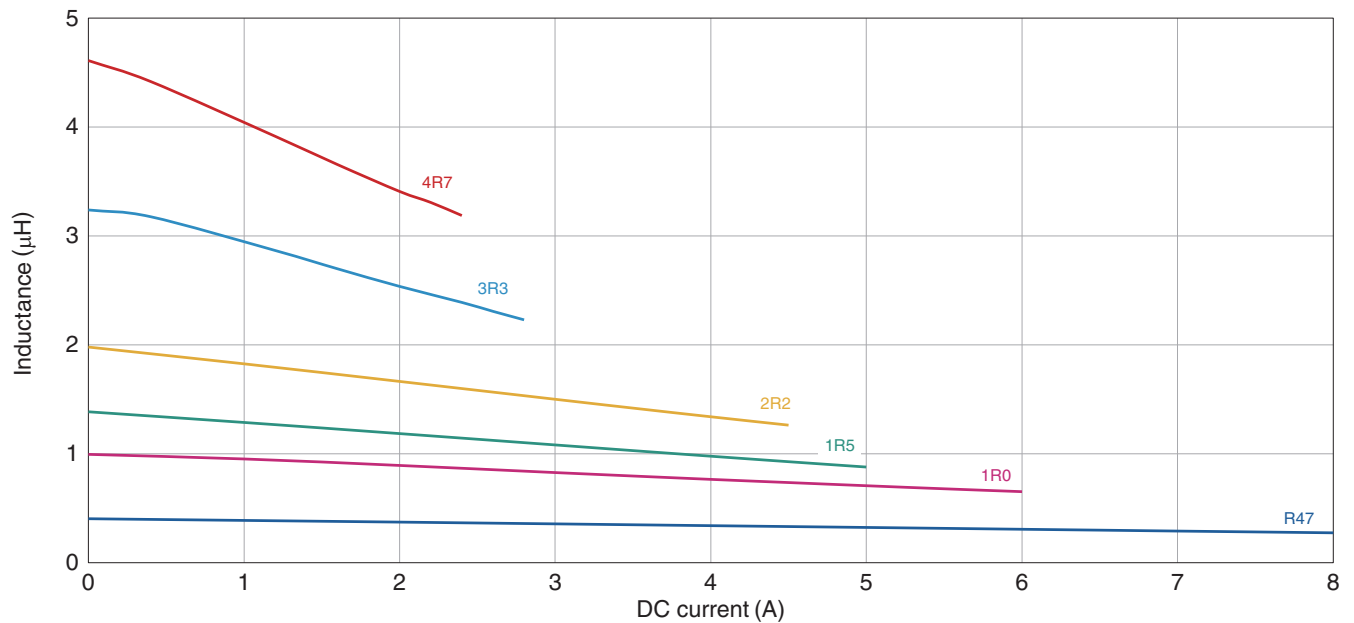

Measurement equipment

Product No. *	Manufacturer
4284A+42841A+42842C	Keysight Technologies

* Equivalent measurement equipment may be used.

SPM3012-LR type

SHAPE & DIMENSIONS

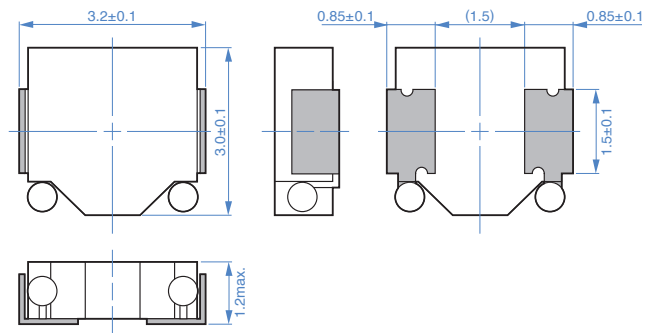

Dimensions in mm

RECOMMENDED LAND PATTERN

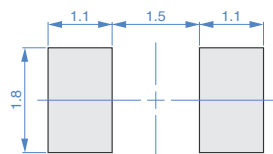

Dimensions in mm

PACKAGING STYLE

REEL DIMENSIONS

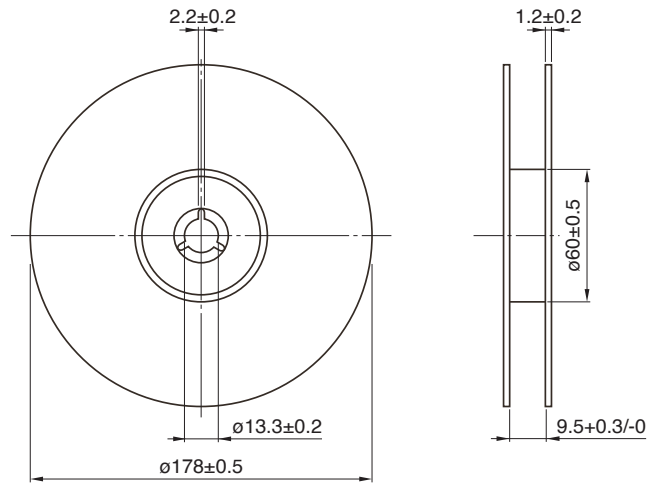

Dimensions in mm

TAPE DIMENSIONS

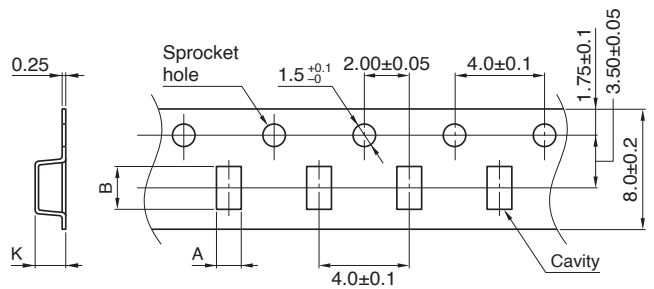

Dimensions in mm

Type	A	B	K
SPM3012-LR	3.3	3.5	1.35

PACKAGE QUANTITY

Package quantity	2000 pcs/reel
------------------	---------------

RECOMMENDED REFLOW PROFILE

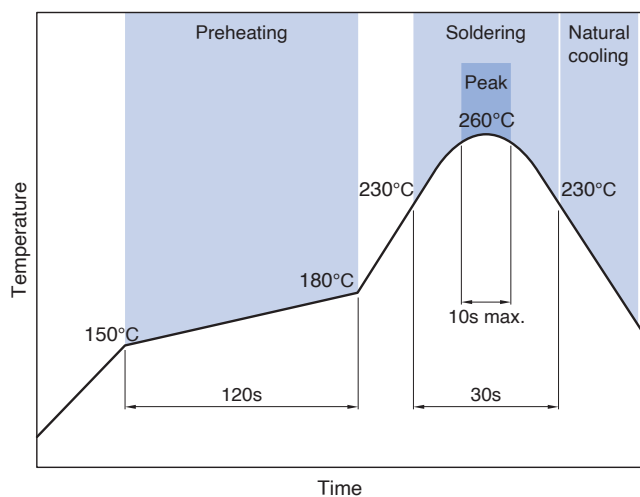

TEMPERATURE RANGE, INDIVIDUAL WEIGHT

Operating temperature range *	Storage temperature range **	Individual weight
-40 to +125 °C	-40 to +125 °C	0.05 g

* Operating temperature range includes self-heating.

** The storage temperature range is for after the assembly.

REMINDERS FOR USING THESE PRODUCTS

Before using these products, be sure to request the delivery specifications.

SAFETY REMINDERS

Please pay sufficient attention to the warnings for safe designing when using this products

REMINDERS

- The storage period is within 12 months. Be sure to follow the storage conditions (temperature: 5 to 40°C, humidity: 10 to 75% RH or less).
If the storage period elapses, the soldering of the terminal electrodes may deteriorate.
- Do not use or store in locations where there are conditions such as gas corrosion (salt, acid, alkali, etc.).
- Be sure to preheat the product before soldering.
The temperature difference between the solder and the product during preheating should be within 150°C.
- Soldering corrections after mounting should be within the range of the conditions determined in the specifications.
If overheated, a short circuit, performance deterioration, or lifespan shortening may occur.
- Do not use products that have received any excessive mechanical shock such as by being dropped.
- When embedding a printed circuit board where a chip is mounted to a set, be sure that residual stress is not given to the chip due to the overall distortion of the printed circuit board and partial distortion such as at screw tightening portions.
- Self heating (temperature increase) occurs when the power is turned ON, so the tolerance should be sufficient for the set thermal design.
- Carefully lay out the coil for the circuit board design of the non-magnetic shield type.
A malfunction may occur due to magnetic interference.
- Use a wrist band to discharge static electricity in your body through the grounding wire.
- Do not expose the products to magnets or magnetic fields.
- The performance of the product may deteriorate if coating materials are used, thus please assess the situation beforehand by taking this factor into consideration.
- Do not use for a purpose outside of the contents regulated in the delivery specifications.
- The products described in this catalog are intended to be installed in automobiles or automotive electronic equipment (AV equipment, telecommunications equipment, home appliances, amusement equipment, computer equipment, personal equipment, office equipment, measurement equipment, industrial robots) and to be used in automobiles (including the case where the said automotive product is mounted in a vehicle) or standard applications as general electronic equipment in automotive applications or standard applications as general electronic equipment in automotive applications in accordance with the scope and conditions described in this specification, while the said automotive or general electronic equipment including the said product is intended to be used in the usual operation and usage methods, respectively. Other than automotive or automotive products are not designed or warranted to meet the requirements of the applications listed below, whose performance and/or quality requires a more stringent level of safety or reliability, or whose failure, malfunction or defect could cause serious damage to society, person or property.
Please understand that we are not responsible for any damage or liability caused by use of the products in any of the applications below or for any other use exceeding the range or conditions set forth in this specification sheet.
If you intend to use the products in the applications listed below or if you have special requirements exceeding the range or conditions set forth in this specification, please contact us.

- (1) Aerospace/aviation equipment
- (2) Transportation equipment (cars, electric trains, ships, etc.)
- (3) Medical equipment
- (4) Power-generation control equipment
- (5) Atomic energy-related equipment
- (6) Seabed equipment

- (7) Transportation control equipment
- (8) Public information-processing equipment
- (9) Military equipment
- (10) Electric heating apparatus, burning equipment
- (11) Disaster prevention/crime prevention equipment
- (12) Safety equipment
- (13) Other applications that are not considered general-purpose applications

When designing your equipment even for general-purpose applications, you are kindly requested to take into consideration securing protection circuit/device or providing backup circuits in your equipment.