

Inductors for high frequency circuits  
Multilayer ceramic  
MLG-P series



## MLG0402P type



### FEATURES

- High Q type inductor for high-frequency circuits.
- Inductance range: from 0.2 to 33nH.
- 0.1n step inductance lineup.
- Compared with existing products, the size was greatly reduced, making it optimal for fine-pitch circuits.
- Optimal configuration that greatly improves the Q to 800MHz or higher.
- Advanced monolithic structure is formed using a multilayering and sintering process with ceramic and conductive materials for high-frequency.
- Operating temperature range: -55 to +125°C

### APPLICATION

- Smart phones, tablet terminals, high frequency modules, Bluetooth, W-LAN, UWB, tuners and other high frequency circuits for the mobile communication industry
- Application guides: [Smart phones/tablets](#)

### PART NUMBER CONSTRUCTION

MLG	0402	P	0N2	B	T	000
Series name	L×W×H dimensions 0.4×0.2×0.2 mm	Characteristics	Inductance (nH)	Inductance tolerance	Packaging style	Internal code

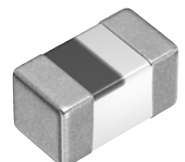

## MLG0402P type

## CHARACTERISTICS SPECIFICATION TABLE

L (nH)	Q Tolerance	Q min.	L, Q measuring frequency (MHz)	Self-resonant frequency		DC resistance		Rated current (mA)max.	Part No.*
				(GHz)min.	(GHz)typ.	( $\Omega$ )max.	( $\Omega$ )typ.		
0.2	$\pm 0.1$ nH	—	500	10.0	20.0	0.1	0.03	350	<a href="#">MLG0402P0N2BT000</a>
0.2	$\pm 0.2$ nH	—	500	10.0	20.0	0.1	0.03	350	<a href="#">MLG0402P0N2CT000</a>
0.3	$\pm 0.1$ nH	—	500	10.0	20.0	0.1	0.03	350	<a href="#">MLG0402P0N3BT000</a>
0.3	$\pm 0.2$ nH	—	500	10.0	20.0	0.1	0.03	350	<a href="#">MLG0402P0N3CT000</a>
0.4	$\pm 0.1$ nH	—	500	10.0	20.0	0.2	0.07	350	<a href="#">MLG0402P0N4BT000</a>
0.4	$\pm 0.2$ nH	—	500	10.0	20.0	0.2	0.07	350	<a href="#">MLG0402P0N4CT000</a>
0.4	$\pm 0.3$ nH	—	500	10.0	20.0	0.2	0.07	350	<a href="#">MLG0402P0N4ST000</a>
0.5	$\pm 0.1$ nH	—	500	10.0	20.0	0.2	0.08	350	<a href="#">MLG0402P0N5BT000</a>
0.5	$\pm 0.2$ nH	—	500	10.0	20.0	0.2	0.08	350	<a href="#">MLG0402P0N5CT000</a>
0.5	$\pm 0.3$ nH	—	500	10.0	20.0	0.2	0.08	350	<a href="#">MLG0402P0N5ST000</a>
0.6	$\pm 0.1$ nH	—	500	10.0	20.0	0.2	0.11	350	<a href="#">MLG0402P0N6BT000</a>
0.6	$\pm 0.2$ nH	—	500	10.0	20.0	0.2	0.11	350	<a href="#">MLG0402P0N6CT000</a>
0.6	$\pm 0.3$ nH	—	500	10.0	20.0	0.2	0.11	350	<a href="#">MLG0402P0N6ST000</a>
0.7	$\pm 0.1$ nH	—	500	10.0	20.0	0.3	0.13	320	<a href="#">MLG0402P0N7BT000</a>
0.7	$\pm 0.2$ nH	—	500	10.0	20.0	0.3	0.13	320	<a href="#">MLG0402P0N7CT000</a>
0.7	$\pm 0.3$ nH	—	500	10.0	20.0	0.3	0.13	320	<a href="#">MLG0402P0N7ST000</a>
0.8	$\pm 0.1$ nH	—	500	10.0	18.3	0.4	0.11	320	<a href="#">MLG0402P0N8BT000</a>
0.8	$\pm 0.2$ nH	—	500	10.0	18.3	0.4	0.11	320	<a href="#">MLG0402P0N8CT000</a>
0.8	$\pm 0.3$ nH	—	500	10.0	18.3	0.4	0.11	320	<a href="#">MLG0402P0N8ST000</a>
0.9	$\pm 0.1$ nH	—	500	10.0	17.3	0.4	0.15	320	<a href="#">MLG0402P0N9BT000</a>
0.9	$\pm 0.2$ nH	—	500	10.0	17.3	0.4	0.15	320	<a href="#">MLG0402P0N9CT000</a>
0.9	$\pm 0.3$ nH	—	500	10.0	17.3	0.4	0.15	320	<a href="#">MLG0402P0N9ST000</a>
1.0	$\pm 0.1$ nH	8	500	10.0	16.5	0.4	0.20	250	<a href="#">MLG0402P1N0BT000</a>
1.0	$\pm 0.2$ nH	8	500	10.0	16.5	0.4	0.20	250	<a href="#">MLG0402P1N0CT000</a>
1.0	$\pm 0.3$ nH	8	500	10.0	16.5	0.4	0.20	250	<a href="#">MLG0402P1N0ST000</a>
1.1	$\pm 0.1$ nH	8	500	10.0	15.0	0.5	0.22	250	<a href="#">MLG0402P1N1BT000</a>
1.1	$\pm 0.2$ nH	8	500	10.0	15.0	0.5	0.22	250	<a href="#">MLG0402P1N1CT000</a>
1.1	$\pm 0.3$ nH	8	500	10.0	15.0	0.5	0.22	250	<a href="#">MLG0402P1N1ST000</a>
1.2	$\pm 0.1$ nH	8	500	10.0	14.8	0.5	0.25	250	<a href="#">MLG0402P1N2BT000</a>
1.2	$\pm 0.2$ nH	8	500	10.0	14.8	0.5	0.25	250	<a href="#">MLG0402P1N2CT000</a>
1.2	$\pm 0.3$ nH	8	500	10.0	14.8	0.5	0.25	250	<a href="#">MLG0402P1N2ST000</a>
1.3	$\pm 0.1$ nH	8	500	10.0	15.9	0.6	0.28	250	<a href="#">MLG0402P1N3BT000</a>
1.3	$\pm 0.2$ nH	8	500	10.0	15.9	0.6	0.28	250	<a href="#">MLG0402P1N3CT000</a>
1.3	$\pm 0.3$ nH	8	500	10.0	15.9	0.6	0.28	250	<a href="#">MLG0402P1N3ST000</a>
1.4	$\pm 0.1$ nH	7	500	10.0	14.0	0.6	0.30	250	<a href="#">MLG0402P1N4BT000</a>
1.4	$\pm 0.2$ nH	7	500	10.0	14.0	0.6	0.30	250	<a href="#">MLG0402P1N4CT000</a>
1.4	$\pm 0.3$ nH	7	500	10.0	14.0	0.6	0.30	250	<a href="#">MLG0402P1N4ST000</a>
1.5	$\pm 0.1$ nH	8	500	10.0	14.0	0.6	0.37	220	<a href="#">MLG0402P1N5BT000</a>
1.5	$\pm 0.2$ nH	8	500	10.0	14.0	0.6	0.37	220	<a href="#">MLG0402P1N5CT000</a>
1.5	$\pm 0.3$ nH	8	500	10.0	14.0	0.6	0.37	220	<a href="#">MLG0402P1N5ST000</a>
1.6	$\pm 0.1$ nH	9	500	9.0	12.9	0.6	0.25	220	<a href="#">MLG0402P1N6BT000</a>
1.6	$\pm 0.2$ nH	9	500	9.0	12.9	0.6	0.25	220	<a href="#">MLG0402P1N6CT000</a>
1.6	$\pm 0.3$ nH	9	500	9.0	12.9	0.6	0.25	220	<a href="#">MLG0402P1N6ST000</a>
1.7	$\pm 0.1$ nH	9	500	9.0	12.4	0.6	0.25	200	<a href="#">MLG0402P1N7BT000</a>
1.7	$\pm 0.2$ nH	9	500	9.0	12.4	0.6	0.25	200	<a href="#">MLG0402P1N7CT000</a>
1.7	$\pm 0.3$ nH	9	500	9.0	12.4	0.6	0.25	200	<a href="#">MLG0402P1N7ST000</a>

\* Short bar residual inductance =0.11nH

## Measurement equipment

Measurement item	Product No.	Manufacturer
L, Q	4291B+16196D	Keysight Technologies
Self-resonant frequency	8720C	Keysight Technologies
DC resistance	4338A	Keysight Technologies

\* Equivalent measurement equipment may be used.

## MLG0402P type

## CHARACTERISTICS SPECIFICATION TABLE

L (nH)	Q Tolerance	Q min.	L, Q measuring frequency (MHz)	Self-resonant frequency		DC resistance		Rated current (mA)max.	Part No.*
				(GHz)min.	(GHz)typ.	( $\Omega$ )max.	( $\Omega$ )typ.		
1.8	$\pm 0.1$ nH	9	500	8.0	11.5	0.6	0.28	200	<a href="#">MLG0402P1N8BT000</a>
1.8	$\pm 0.2$ nH	9	500	8.0	11.5	0.6	0.28	200	<a href="#">MLG0402P1N8CT000</a>
1.8	$\pm 0.3$ nH	9	500	8.0	11.5	0.6	0.28	200	<a href="#">MLG0402P1N8ST000</a>
1.9	$\pm 0.1$ nH	9	500	8.0	10.5	0.6	0.27	200	<a href="#">MLG0402P1N9BT000</a>
1.9	$\pm 0.2$ nH	9	500	8.0	10.5	0.6	0.27	200	<a href="#">MLG0402P1N9CT000</a>
1.9	$\pm 0.3$ nH	9	500	8.0	10.5	0.6	0.27	200	<a href="#">MLG0402P1N9ST000</a>
2.0	$\pm 0.1$ nH	9	500	8.0	11.0	0.6	0.30	200	<a href="#">MLG0402P2N0BT000</a>
2.0	$\pm 0.2$ nH	9	500	8.0	11.0	0.6	0.30	200	<a href="#">MLG0402P2N0CT000</a>
2.0	$\pm 0.3$ nH	9	500	8.0	11.0	0.6	0.30	200	<a href="#">MLG0402P2N0ST000</a>
2.1	$\pm 0.1$ nH	8	500	8.0	11.5	0.7	0.36	200	<a href="#">MLG0402P2N1BT000</a>
2.1	$\pm 0.2$ nH	8	500	8.0	11.5	0.7	0.36	200	<a href="#">MLG0402P2N1CT000</a>
2.1	$\pm 0.3$ nH	8	500	8.0	11.5	0.7	0.36	200	<a href="#">MLG0402P2N1ST000</a>
2.2	$\pm 0.1$ nH	8	500	8.0	10.7	0.7	0.43	200	<a href="#">MLG0402P2N2BT000</a>
2.2	$\pm 0.2$ nH	8	500	8.0	10.7	0.7	0.43	200	<a href="#">MLG0402P2N2CT000</a>
2.2	$\pm 0.3$ nH	8	500	8.0	10.7	0.7	0.43	200	<a href="#">MLG0402P2N2ST000</a>
2.3	$\pm 0.1$ nH	8	500	7.0	10.3	0.7	0.46	200	<a href="#">MLG0402P2N3BT000</a>
2.3	$\pm 0.2$ nH	8	500	7.0	10.3	0.7	0.46	200	<a href="#">MLG0402P2N3CT000</a>
2.3	$\pm 0.3$ nH	8	500	7.0	10.3	0.7	0.46	200	<a href="#">MLG0402P2N3ST000</a>
2.4	$\pm 0.1$ nH	8	500	7.0	10.2	0.7	0.43	200	<a href="#">MLG0402P2N4BT000</a>
2.4	$\pm 0.2$ nH	8	500	7.0	10.2	0.7	0.43	200	<a href="#">MLG0402P2N4CT000</a>
2.4	$\pm 0.3$ nH	8	500	7.0	10.2	0.7	0.43	200	<a href="#">MLG0402P2N4ST000</a>
2.5	$\pm 0.1$ nH	8	500	7.0	10.3	0.8	0.54	200	<a href="#">MLG0402P2N5BT000</a>
2.5	$\pm 0.2$ nH	8	500	7.0	10.3	0.8	0.54	200	<a href="#">MLG0402P2N5CT000</a>
2.5	$\pm 0.3$ nH	8	500	7.0	10.3	0.8	0.54	200	<a href="#">MLG0402P2N5ST000</a>
2.6	$\pm 0.1$ nH	8	500	7.0	9.7	0.8	0.54	200	<a href="#">MLG0402P2N6BT000</a>
2.6	$\pm 0.2$ nH	8	500	7.0	9.7	0.8	0.54	200	<a href="#">MLG0402P2N6CT000</a>
2.6	$\pm 0.3$ nH	8	500	7.0	9.7	0.8	0.54	200	<a href="#">MLG0402P2N6ST000</a>
2.7	$\pm 0.1$ nH	8	500	7.0	9.9	0.8	0.54	200	<a href="#">MLG0402P2N7BT000</a>
2.7	$\pm 0.2$ nH	8	500	7.0	9.9	0.8	0.54	200	<a href="#">MLG0402P2N7CT000</a>
2.7	$\pm 0.3$ nH	8	500	7.0	9.9	0.8	0.54	200	<a href="#">MLG0402P2N7ST000</a>
2.8	$\pm 0.1$ nH	8	500	7.0	9.2	0.8	0.52	200	<a href="#">MLG0402P2N8BT000</a>
2.8	$\pm 0.2$ nH	8	500	7.0	9.2	0.8	0.52	200	<a href="#">MLG0402P2N8CT000</a>
2.8	$\pm 0.3$ nH	8	500	7.0	9.2	0.8	0.52	200	<a href="#">MLG0402P2N8ST000</a>
2.9	$\pm 0.1$ nH	8	500	7.0	9.6	0.8	0.45	200	<a href="#">MLG0402P2N9BT000</a>
2.9	$\pm 0.2$ nH	8	500	7.0	9.6	0.8	0.45	200	<a href="#">MLG0402P2N9CT000</a>
2.9	$\pm 0.3$ nH	8	500	7.0	9.6	0.8	0.45	200	<a href="#">MLG0402P2N9ST000</a>
3.0	$\pm 0.1$ nH	8	500	7.0	9.2	0.9	0.58	200	<a href="#">MLG0402P3N0BT000</a>
3.0	$\pm 0.2$ nH	8	500	7.0	9.2	0.9	0.58	200	<a href="#">MLG0402P3N0CT000</a>
3.0	$\pm 0.3$ nH	8	500	7.0	9.2	0.9	0.58	200	<a href="#">MLG0402P3N0ST000</a>
3.1	$\pm 0.1$ nH	8	500	7.0	9.2	1.0	0.66	200	<a href="#">MLG0402P3N1BT000</a>
3.1	$\pm 0.2$ nH	8	500	7.0	9.2	1.0	0.66	200	<a href="#">MLG0402P3N1CT000</a>
3.1	$\pm 0.3$ nH	8	500	7.0	9.2	1.0	0.66	200	<a href="#">MLG0402P3N1ST000</a>
3.2	$\pm 0.1$ nH	8	500	7.0	9.1	1.1	0.73	180	<a href="#">MLG0402P3N2BT000</a>
3.2	$\pm 0.2$ nH	8	500	7.0	9.1	1.1	0.73	180	<a href="#">MLG0402P3N2CT000</a>
3.2	$\pm 0.3$ nH	8	500	7.0	9.1	1.1	0.73	180	<a href="#">MLG0402P3N2ST000</a>

\* Short bar residual inductance =0.11nH

## Measurement equipment

Measurement item	Product No.	Manufacturer
L, Q	4291B+16196D	Keysight Technologies
Self-resonant frequency	8720C	Keysight Technologies
DC resistance	4338A	Keysight Technologies

\* Equivalent measurement equipment may be used.

## MLG0402P type

## CHARACTERISTICS SPECIFICATION TABLE

L (nH)	Q Tolerance	Q min.	L, Q measuring frequency (MHz)	Self-resonant frequency		DC resistance		Rated current (mA)max.	Part No.*
				(GHz)min.	(GHz)typ.	( $\Omega$ )max.	( $\Omega$ )typ.		
3.3	$\pm 0.1$ nH	8	500	6.5	8.6	1.1	0.73	180	<a href="#">MLG0402P3N3BT000</a>
3.3	$\pm 0.2$ nH	8	500	6.5	8.6	1.1	0.73	180	<a href="#">MLG0402P3N3CT000</a>
3.3	$\pm 0.3$ nH	8	500	6.5	8.6	1.1	0.73	180	<a href="#">MLG0402P3N3ST000</a>
3.4	$\pm 0.1$ nH	8	500	6.0	8.6	1.1	0.74	180	<a href="#">MLG0402P3N4BT000</a>
3.4	$\pm 0.2$ nH	8	500	6.0	8.6	1.1	0.74	180	<a href="#">MLG0402P3N4CT000</a>
3.4	$\pm 0.3$ nH	8	500	6.0	8.6	1.1	0.74	180	<a href="#">MLG0402P3N4ST000</a>
3.5	$\pm 0.1$ nH	8	500	6.0	8.3	1.1	0.75	180	<a href="#">MLG0402P3N5BT000</a>
3.5	$\pm 0.2$ nH	8	500	6.0	8.3	1.1	0.75	180	<a href="#">MLG0402P3N5CT000</a>
3.5	$\pm 0.3$ nH	8	500	6.0	8.3	1.1	0.75	180	<a href="#">MLG0402P3N5ST000</a>
3.6	$\pm 0.1$ nH	8	500	6.0	8.3	1.1	0.73	180	<a href="#">MLG0402P3N6BT000</a>
3.6	$\pm 0.2$ nH	8	500	6.0	8.3	1.1	0.73	180	<a href="#">MLG0402P3N6CT000</a>
3.6	$\pm 0.3$ nH	8	500	6.0	8.3	1.1	0.73	180	<a href="#">MLG0402P3N6ST000</a>
3.7	$\pm 0.1$ nH	8	500	6.0	8.0	1.1	0.70	180	<a href="#">MLG0402P3N7BT000</a>
3.7	$\pm 0.2$ nH	8	500	6.0	8.0	1.1	0.70	180	<a href="#">MLG0402P3N7CT000</a>
3.7	$\pm 0.3$ nH	8	500	6.0	8.0	1.1	0.70	180	<a href="#">MLG0402P3N7ST000</a>
3.8	$\pm 0.1$ nH	8	500	6.0	7.8	1.2	0.77	180	<a href="#">MLG0402P3N8BT000</a>
3.8	$\pm 0.2$ nH	8	500	6.0	7.8	1.2	0.77	180	<a href="#">MLG0402P3N8CT000</a>
3.8	$\pm 0.3$ nH	8	500	6.0	7.8	1.2	0.77	180	<a href="#">MLG0402P3N8ST000</a>
3.9	$\pm 0.1$ nH	8	500	6.0	7.6	1.2	0.71	180	<a href="#">MLG0402P3N9BT000</a>
3.9	$\pm 0.2$ nH	8	500	6.0	7.6	1.2	0.71	180	<a href="#">MLG0402P3N9CT000</a>
3.9	$\pm 0.3$ nH	8	500	6.0	7.6	1.2	0.71	180	<a href="#">MLG0402P3N9ST000</a>
4.0	$\pm 0.1$ nH	8	500	6.0	7.5	1.2	0.73	180	<a href="#">MLG0402P4N0BT000</a>
4.0	$\pm 0.2$ nH	8	500	6.0	7.5	1.2	0.73	180	<a href="#">MLG0402P4N0CT000</a>
4.0	$\pm 0.3$ nH	8	500	6.0	7.5	1.2	0.73	180	<a href="#">MLG0402P4N0ST000</a>
4.1	$\pm 0.1$ nH	8	500	6.0	7.9	1.2	0.75	180	<a href="#">MLG0402P4N1BT000</a>
4.1	$\pm 0.2$ nH	8	500	6.0	7.9	1.2	0.75	180	<a href="#">MLG0402P4N1CT000</a>
4.1	$\pm 0.3$ nH	8	500	6.0	7.9	1.2	0.75	180	<a href="#">MLG0402P4N1ST000</a>
4.2	$\pm 0.1$ nH	8	500	6.0	7.9	1.2	0.77	180	<a href="#">MLG0402P4N2BT000</a>
4.2	$\pm 0.2$ nH	8	500	6.0	7.9	1.2	0.77	180	<a href="#">MLG0402P4N2CT000</a>
4.2	$\pm 0.3$ nH	8	500	6.0	7.9	1.2	0.77	180	<a href="#">MLG0402P4N2ST000</a>
4.3	$\pm 0.3$ nH	8	500	6.0	8.0	1.2	0.80	180	<a href="#">MLG0402P4N3ST000</a>
4.3	$\pm 3\%$	8	500	6.0	8.0	1.2	0.80	180	<a href="#">MLG0402P4N3HT000</a>
4.3	$\pm 5\%$	8	500	6.0	8.0	1.2	0.80	180	<a href="#">MLG0402P4N3JT000</a>
4.7	$\pm 0.3$ nH	8	500	5.0	7.2	1.3	0.88	160	<a href="#">MLG0402P4N7ST000</a>
4.7	$\pm 3\%$	8	500	5.0	7.2	1.3	0.88	160	<a href="#">MLG0402P4N7HT000</a>
4.7	$\pm 5\%$	8	500	5.0	7.2	1.3	0.88	160	<a href="#">MLG0402P4N7JT000</a>
5.1	$\pm 0.3$ nH	8	500	5.0	7.0	1.4	0.90	160	<a href="#">MLG0402P5N1ST000</a>
5.1	$\pm 3\%$	8	500	5.0	7.0	1.4	0.90	160	<a href="#">MLG0402P5N1HT000</a>
5.1	$\pm 5\%$	8	500	5.0	7.0	1.4	0.90	160	<a href="#">MLG0402P5N1JT000</a>
5.6	$\pm 0.3$ nH	8	500	5.0	6.8	1.5	1.02	140	<a href="#">MLG0402P5N6ST000</a>
5.6	$\pm 3\%$	8	500	5.0	6.8	1.5	1.02	140	<a href="#">MLG0402P5N6HT000</a>
5.6	$\pm 5\%$	8	500	5.0	6.8	1.5	1.02	140	<a href="#">MLG0402P5N6JT000</a>
6.2	$\pm 3\%$	8	500	4.5	6.5	1.5	1.04	140	<a href="#">MLG0402P6N2HT000</a>
6.2	$\pm 5\%$	8	500	4.5	6.5	1.5	1.04	140	<a href="#">MLG0402P6N2JT000</a>

\* Short bar residual inductance =0.11nH

## Measurement equipment

Measurement item	Product No.	Manufacturer
L, Q	4291B+16196D	Keysight Technologies
Self-resonant frequency	8720C	Keysight Technologies
DC resistance	4338A	Keysight Technologies

\* Equivalent measurement equipment may be used.

## MLG0402P type

## CHARACTERISTICS SPECIFICATION TABLE

L (nH)	Q Tolerance	Q min.	L, Q measuring frequency (MHz)	Self-resonant frequency		DC resistance		Rated current (mA)max.	Part No.*
				(GHz)min.	(GHz)typ.	( $\Omega$ )max.	( $\Omega$ )typ.		
6.8	$\pm 3\%$	8	500	4.3	5.8	1.6	1.12	140	<a href="#">MLG0402P6N8HT000</a>
6.8	$\pm 5\%$	8	500	4.3	5.8	1.6	1.12	140	<a href="#">MLG0402P6N8JT000</a>
7.5	$\pm 3\%$	8	500	4.2	5.7	1.7	1.13	140	<a href="#">MLG0402P7N5HT000</a>
7.5	$\pm 5\%$	8	500	4.2	5.7	1.7	1.13	140	<a href="#">MLG0402P7N5JT000</a>
8.2	$\pm 3\%$	8	500	4.0	5.5	1.8	1.16	140	<a href="#">MLG0402P8N2HT000</a>
8.2	$\pm 5\%$	8	500	4.0	5.5	1.8	1.16	140	<a href="#">MLG0402P8N2JT000</a>
9.1	$\pm 3\%$	8	500	4.0	5.5	1.8	1.20	140	<a href="#">MLG0402P9N1HT000</a>
9.1	$\pm 5\%$	8	500	4.0	5.5	1.8	1.20	140	<a href="#">MLG0402P9N1JT000</a>
10.0	$\pm 3\%$	8	500	3.6	4.7	2.1	1.45	140	<a href="#">MLG0402P10NHT000</a>
10.0	$\pm 5\%$	8	500	3.6	4.7	2.1	1.45	140	<a href="#">MLG0402P10NJT000</a>
11.0	$\pm 3\%$	8	500	3.5	4.6	2.2	1.51	140	<a href="#">MLG0402P11NHT000</a>
11.0	$\pm 5\%$	8	500	3.5	4.6	2.2	1.51	140	<a href="#">MLG0402P11NJT000</a>
12.0	$\pm 3\%$	8	500	3.4	4.5	2.4	1.64	140	<a href="#">MLG0402P12NHT000</a>
12.0	$\pm 5\%$	8	500	3.4	4.5	2.4	1.64	140	<a href="#">MLG0402P12NJT000</a>
13.0	$\pm 3\%$	8	500	3.2	4.3	2.5	1.71	140	<a href="#">MLG0402P13NHT000</a>
13.0	$\pm 5\%$	8	500	3.2	4.3	2.5	1.71	140	<a href="#">MLG0402P13NJT000</a>
15.0	$\pm 3\%$	8	500	3.0	3.9	2.6	1.77	140	<a href="#">MLG0402P15NHT000</a>
15.0	$\pm 5\%$	8	500	3.0	3.9	2.6	1.77	140	<a href="#">MLG0402P15NJT000</a>
16.0	$\pm 3\%$	7	500	2.4	3.4	2.7	1.79	140	<a href="#">MLG0402P16NHT000</a>
16.0	$\pm 5\%$	7	500	2.4	3.4	2.7	1.79	140	<a href="#">MLG0402P16NJT000</a>
18.0	$\pm 3\%$	7	500	2.3	3.2	2.8	1.94	140	<a href="#">MLG0402P18NHT000</a>
18.0	$\pm 5\%$	7	500	2.3	3.2	2.8	1.94	140	<a href="#">MLG0402P18NJT000</a>
20.0	$\pm 3\%$	7	500	2.2	2.8	3.0	2.09	130	<a href="#">MLG0402P20NHT000</a>
20.0	$\pm 5\%$	7	500	2.2	2.8	3.0	2.09	130	<a href="#">MLG0402P20NJT000</a>
22.0	$\pm 3\%$	7	500	2.0	2.7	3.2	2.18	130	<a href="#">MLG0402P22NHT000</a>
22.0	$\pm 5\%$	7	500	2.0	2.7	3.2	2.18	130	<a href="#">MLG0402P22NJT000</a>
24.0	$\pm 3\%$	7	500	2.0	2.6	3.2	2.30	120	<a href="#">MLG0402P24NHT000</a>
24.0	$\pm 5\%$	7	500	2.0	2.6	3.2	2.30	120	<a href="#">MLG0402P24NJT000</a>
27.0	$\pm 3\%$	7	500	1.8	2.3	3.5	2.44	120	<a href="#">MLG0402P27NHT000</a>
27.0	$\pm 5\%$	7	500	1.8	2.3	3.5	2.44	120	<a href="#">MLG0402P27NJT000</a>
30.0	$\pm 3\%$	7	500	1.7	2.2	3.6	2.56	120	<a href="#">MLG0402P30NHT000</a>
30.0	$\pm 5\%$	7	500	1.7	2.2	3.6	2.56	120	<a href="#">MLG0402P30NJT000</a>
33.0	$\pm 3\%$	6	300	1.4	1.9	3.8	2.71	120	<a href="#">MLG0402P33NHT000</a>
33.0	$\pm 5\%$	6	300	1.4	1.9	3.8	2.71	120	<a href="#">MLG0402P33NJT000</a>

\* Short bar residual inductance =0.11nH

## Measurement equipment

Measurement item	Product No.	Manufacturer
L, Q	4291B+16196D	Keysight Technologies
Self-resonant frequency	8720C	Keysight Technologies
DC resistance	4338A	Keysight Technologies

\* Equivalent measurement equipment may be used.

## MLG0402P type

## L, Q FREQUENCY CHARACTERISTICS TABLE

L(nH)typ.					Q typ.					Part No.
500MHz	800MHz	1.8GHz	2.0GHz	2.4GHz	500MHz	800MHz	1.8GHz	2.0GHz	2.4GHz	
0.2	0.2	0.2	0.2	0.2	12	15	23	25	29	<a href="#">MLG0402P0N2BT000</a>
0.2	0.2	0.2	0.2	0.2	12	15	23	25	29	<a href="#">MLG0402P0N2CT000</a>
0.3	0.3	0.3	0.3	0.3	17	22	35	39	44	<a href="#">MLG0402P0N3BT000</a>
0.3	0.3	0.3	0.3	0.3	17	22	35	39	44	<a href="#">MLG0402P0N3CT000</a>
0.4	0.4	0.4	0.4	0.4	12	15	22	24	26	<a href="#">MLG0402P0N4BT000</a>
0.4	0.4	0.4	0.4	0.4	12	15	22	24	26	<a href="#">MLG0402P0N4CT000</a>
0.4	0.4	0.4	0.4	0.4	12	15	22	24	26	<a href="#">MLG0402P0N4ST000</a>
0.5	0.5	0.5	0.5	0.5	12	16	25	27	30	<a href="#">MLG0402P0N5BT000</a>
0.5	0.5	0.5	0.5	0.5	12	16	25	27	30	<a href="#">MLG0402P0N5CT000</a>
0.5	0.5	0.5	0.5	0.5	12	16	25	27	30	<a href="#">MLG0402P0N5ST000</a>
0.6	0.6	0.6	0.6	0.6	11	15	23	26	29	<a href="#">MLG0402P0N6BT000</a>
0.6	0.6	0.6	0.6	0.6	11	15	23	26	29	<a href="#">MLG0402P0N6CT000</a>
0.6	0.6	0.6	0.6	0.6	11	15	23	26	29	<a href="#">MLG0402P0N6ST000</a>
0.7	0.7	0.7	0.7	0.7	10	14	22	25	28	<a href="#">MLG0402P0N7BT000</a>
0.7	0.7	0.7	0.7	0.7	10	14	22	25	28	<a href="#">MLG0402P0N7CT000</a>
0.7	0.7	0.7	0.7	0.7	10	14	22	25	28	<a href="#">MLG0402P0N7ST000</a>
0.8	0.8	0.8	0.8	0.8	12	15	23	25	27	<a href="#">MLG0402P0N8BT000</a>
0.8	0.8	0.8	0.8	0.8	12	15	23	25	27	<a href="#">MLG0402P0N8CT000</a>
0.8	0.8	0.8	0.8	0.8	12	15	23	25	27	<a href="#">MLG0402P0N8ST000</a>
0.9	0.9	0.9	0.9	0.9	12	15	23	25	27	<a href="#">MLG0402P0N9BT000</a>
0.9	0.9	0.9	0.9	0.9	12	15	23	25	27	<a href="#">MLG0402P0N9CT000</a>
0.9	0.9	0.9	0.9	0.9	12	15	23	25	27	<a href="#">MLG0402P0N9ST000</a>
1.0	1.0	1.0	1.0	1.0	12	16	24	26	29	<a href="#">MLG0402P1N0BT000</a>
1.0	1.0	1.0	1.0	1.0	12	16	24	26	29	<a href="#">MLG0402P1N0CT000</a>
1.0	1.0	1.0	1.0	1.0	12	16	24	26	29	<a href="#">MLG0402P1N0ST000</a>
1.1	1.1	1.1	1.1	1.1	12	15	23	25	28	<a href="#">MLG0402P1N1BT000</a>
1.1	1.1	1.1	1.1	1.1	12	15	23	25	28	<a href="#">MLG0402P1N1CT000</a>
1.1	1.1	1.1	1.1	1.1	12	15	23	25	28	<a href="#">MLG0402P1N1ST000</a>
1.2	1.2	1.2	1.2	1.2	12	15	23	25	27	<a href="#">MLG0402P1N2BT000</a>
1.2	1.2	1.2	1.2	1.2	12	15	23	25	27	<a href="#">MLG0402P1N2CT000</a>
1.2	1.2	1.2	1.2	1.2	12	15	23	25	27	<a href="#">MLG0402P1N2ST000</a>
1.3	1.3	1.3	1.3	1.3	11	14	23	25	28	<a href="#">MLG0402P1N3BT000</a>
1.3	1.3	1.3	1.3	1.3	11	14	23	25	28	<a href="#">MLG0402P1N3CT000</a>
1.3	1.3	1.3	1.3	1.3	11	14	23	25	28	<a href="#">MLG0402P1N3ST000</a>
1.4	1.4	1.4	1.4	1.4	9	12	20	21	24	<a href="#">MLG0402P1N4BT000</a>
1.4	1.4	1.4	1.4	1.4	9	12	20	21	24	<a href="#">MLG0402P1N4CT000</a>
1.4	1.4	1.4	1.4	1.4	9	12	20	21	24	<a href="#">MLG0402P1N4ST000</a>
1.5	1.5	1.5	1.5	1.5	10	13	21	23	25	<a href="#">MLG0402P1N5BT000</a>
1.5	1.5	1.5	1.5	1.5	10	13	21	23	25	<a href="#">MLG0402P1N5CT000</a>
1.5	1.5	1.5	1.5	1.5	10	13	21	23	25	<a href="#">MLG0402P1N5ST000</a>
1.6	1.6	1.6	1.6	1.6	12	15	24	26	29	<a href="#">MLG0402P1N6BT000</a>
1.6	1.6	1.6	1.6	1.6	12	15	24	26	29	<a href="#">MLG0402P1N6CT000</a>
1.6	1.6	1.6	1.6	1.6	12	15	24	26	29	<a href="#">MLG0402P1N6ST000</a>
1.7	1.7	1.7	1.7	1.7	12	15	23	25	28	<a href="#">MLG0402P1N7BT000</a>
1.7	1.7	1.7	1.7	1.7	12	15	23	25	28	<a href="#">MLG0402P1N7CT000</a>
1.7	1.7	1.7	1.7	1.7	12	15	23	25	28	<a href="#">MLG0402P1N7ST000</a>

## Measurement equipment

Product No.	Manufacturer
4291B+16196D	Keysight Technologies

\* Equivalent measurement equipment may be used.

## MLG0402P type

## L, Q FREQUENCY CHARACTERISTICS TABLE

L(nH)typ.		Q typ.					Part No.				
500MHz	800MHz	1.8GHz	2.0GHz	2.4GHz	500MHz	800MHz	1.8GHz	2.0GHz	2.4GHz		
1.8	1.8	1.8	1.8	1.8	12	15	24	26	28		MLG0402P1N8BT000
1.8	1.8	1.8	1.8	1.8	12	15	24	26	28		MLG0402P1N8CT000
1.8	1.8	1.8	1.8	1.8	12	15	24	26	28		MLG0402P1N8ST000
1.9	1.9	1.9	1.9	1.9	11	15	23	24	27		MLG0402P1N9BT000
1.9	1.9	1.9	1.9	1.9	11	15	23	24	27		MLG0402P1N9CT000
1.9	1.9	1.9	1.9	1.9	11	15	23	24	27		MLG0402P1N9ST000
2.0	2.0	2.0	2.0	2.0	12	15	24	26	28		MLG0402P2N0BT000
2.0	2.0	2.0	2.0	2.0	12	15	24	26	28		MLG0402P2N0CT000
2.0	2.0	2.0	2.0	2.0	12	15	24	26	28		MLG0402P2N0ST000
2.1	2.1	2.1	2.1	2.1	12	15	24	26	29		MLG0402P2N1BT000
2.1	2.1	2.1	2.1	2.1	12	15	24	26	29		MLG0402P2N1CT000
2.1	2.1	2.1	2.1	2.1	12	15	24	26	29		MLG0402P2N1ST000
2.2	2.2	2.2	2.2	2.2	11	14	23	24	27		MLG0402P2N2BT000
2.2	2.2	2.2	2.2	2.2	11	14	23	24	27		MLG0402P2N2CT000
2.2	2.2	2.2	2.2	2.2	11	14	23	24	27		MLG0402P2N2ST000
2.3	2.3	2.3	2.3	2.3	11	14	22	24	26		MLG0402P2N3BT000
2.3	2.3	2.3	2.3	2.3	11	14	22	24	26		MLG0402P2N3CT000
2.3	2.3	2.3	2.3	2.3	11	14	22	24	26		MLG0402P2N3ST000
2.4	2.4	2.4	2.4	2.4	11	14	22	24	26		MLG0402P2N4BT000
2.4	2.4	2.4	2.4	2.4	11	14	22	24	26		MLG0402P2N4CT000
2.4	2.4	2.4	2.4	2.4	11	14	22	24	26		MLG0402P2N4ST000
2.5	2.5	2.5	2.5	2.5	10	13	21	23	25		MLG0402P2N5BT000
2.5	2.5	2.5	2.5	2.5	10	13	21	23	25		MLG0402P2N5CT000
2.5	2.5	2.5	2.5	2.5	10	13	21	23	25		MLG0402P2N5ST000
2.6	2.6	2.6	2.6	2.6	10	13	21	23	25		MLG0402P2N6BT000
2.6	2.6	2.6	2.6	2.6	10	13	21	23	25		MLG0402P2N6CT000
2.6	2.6	2.6	2.6	2.6	10	13	21	23	25		MLG0402P2N6ST000
2.7	2.7	2.6	2.6	2.7	11	14	22	24	26		MLG0402P2N7BT000
2.7	2.7	2.6	2.6	2.7	11	14	22	24	26		MLG0402P2N7CT000
2.7	2.7	2.6	2.6	2.7	11	14	22	24	26		MLG0402P2N7ST000
2.8	2.8	2.8	2.8	2.8	11	14	21	23	25		MLG0402P2N8BT000
2.8	2.8	2.8	2.8	2.8	11	14	21	23	25		MLG0402P2N8CT000
2.8	2.8	2.8	2.8	2.8	11	14	21	23	25		MLG0402P2N8ST000
2.9	2.9	2.8	2.9	2.9	11	14	21	23	25		MLG0402P2N9BT000
2.9	2.9	2.8	2.9	2.9	11	14	21	23	25		MLG0402P2N9CT000
2.9	2.9	2.8	2.9	2.9	11	14	21	23	25		MLG0402P2N9ST000
3.0	3.0	2.9	3.0	3.0	11	14	20	22	24		MLG0402P3N0BT000
3.0	3.0	2.9	3.0	3.0	11	14	20	22	24		MLG0402P3N0CT000
3.0	3.0	2.9	3.0	3.0	11	14	20	22	24		MLG0402P3N0ST000
3.1	3.0	2.9	3.0	3.0	11	14	20	22	24		MLG0402P3N1BT000
3.1	3.0	2.9	3.0	3.0	11	14	20	22	24		MLG0402P3N1CT000
3.1	3.0	2.9	3.0	3.0	11	14	20	22	24		MLG0402P3N1ST000
3.2	3.2	3.1	3.2	3.2	10	14	21	22	25		MLG0402P3N2BT000
3.2	3.2	3.1	3.2	3.2	10	14	21	22	25		MLG0402P3N2CT000
3.2	3.2	3.1	3.2	3.2	10	14	21	22	25		MLG0402P3N2ST000

## Measurement equipment

Product No.	Manufacturer
4291B+16196D	Keysight Technologies

\* Equivalent measurement equipment may be used.

## MLG0402P type

## L, Q FREQUENCY CHARACTERISTICS TABLE

L(nH)typ.					Q typ.					Part No.
500MHz	800MHz	1.8GHz	2.0GHz	2.4GHz	500MHz	800MHz	1.8GHz	2.0GHz	2.4GHz	
3.3	3.3	3.3	3.3	3.3	10	13	21	22	24	<a href="#">MLG0402P3N3BT000</a>
3.3	3.3	3.3	3.3	3.3	10	13	21	22	24	<a href="#">MLG0402P3N3CT000</a>
3.3	3.3	3.3	3.3	3.3	10	13	21	22	24	<a href="#">MLG0402P3N3ST000</a>
3.4	3.4	3.4	3.4	3.4	10	13	20	21	23	<a href="#">MLG0402P3N4BT000</a>
3.4	3.4	3.4	3.4	3.4	10	13	20	21	23	<a href="#">MLG0402P3N4CT000</a>
3.4	3.4	3.4	3.4	3.4	10	13	20	21	23	<a href="#">MLG0402P3N4ST000</a>
3.5	3.5	3.5	3.5	3.6	10	13	20	22	24	<a href="#">MLG0402P3N5BT000</a>
3.5	3.5	3.5	3.5	3.6	10	13	20	22	24	<a href="#">MLG0402P3N5CT000</a>
3.5	3.5	3.5	3.5	3.6	10	13	20	22	24	<a href="#">MLG0402P3N5ST000</a>
3.6	3.6	3.6	3.6	3.6	10	13	20	21	23	<a href="#">MLG0402P3N6BT000</a>
3.6	3.6	3.6	3.6	3.6	10	13	20	21	23	<a href="#">MLG0402P3N6CT000</a>
3.6	3.6	3.6	3.6	3.6	10	13	20	21	23	<a href="#">MLG0402P3N6ST000</a>
3.7	3.6	3.7	3.7	3.7	10	13	19	21	22	<a href="#">MLG0402P3N7BT000</a>
3.7	3.6	3.7	3.7	3.7	10	13	19	21	22	<a href="#">MLG0402P3N7CT000</a>
3.7	3.6	3.7	3.7	3.7	10	13	19	21	22	<a href="#">MLG0402P3N7ST000</a>
3.8	3.7	3.8	3.8	3.8	10	13	20	21	23	<a href="#">MLG0402P3N8BT000</a>
3.8	3.7	3.8	3.8	3.8	10	13	20	21	23	<a href="#">MLG0402P3N8CT000</a>
3.8	3.7	3.8	3.8	3.8	10	13	20	21	23	<a href="#">MLG0402P3N8ST000</a>
3.9	3.9	3.9	4.0	4.1	10	13	19	20	21	<a href="#">MLG0402P3N9BT000</a>
3.9	3.9	3.9	4.0	4.1	10	13	19	20	21	<a href="#">MLG0402P3N9CT000</a>
3.9	3.9	3.9	4.0	4.1	10	13	19	20	21	<a href="#">MLG0402P3N9ST000</a>
4.0	3.9	4.0	4.0	4.1	10	12	18	19	21	<a href="#">MLG0402P4N0BT000</a>
4.0	3.9	4.0	4.0	4.1	10	12	18	19	21	<a href="#">MLG0402P4N0CT000</a>
4.0	3.9	4.0	4.0	4.1	10	12	18	19	21	<a href="#">MLG0402P4N0ST000</a>
4.1	4.1	4.1	4.1	4.2	11	14	22	23	26	<a href="#">MLG0402P4N1BT000</a>
4.1	4.1	4.1	4.1	4.2	11	14	22	23	26	<a href="#">MLG0402P4N1CT000</a>
4.1	4.1	4.1	4.1	4.2	11	14	22	23	26	<a href="#">MLG0402P4N1ST000</a>
4.2	4.1	4.2	4.2	4.3	11	14	21	23	25	<a href="#">MLG0402P4N2BT000</a>
4.2	4.1	4.2	4.2	4.3	11	14	21	23	25	<a href="#">MLG0402P4N2CT000</a>
4.2	4.1	4.2	4.2	4.3	11	14	21	23	25	<a href="#">MLG0402P4N2ST000</a>
4.3	4.2	4.3	4.3	4.4	10	13	20	22	24	<a href="#">MLG0402P4N3ST000</a>
4.3	4.2	4.3	4.3	4.4	10	13	20	22	24	<a href="#">MLG0402P4N3HT000</a>
4.3	4.2	4.3	4.3	4.4	10	13	20	22	24	<a href="#">MLG0402P4N3JT000</a>
4.7	4.6	4.7	4.8	4.9	11	14	21	22	24	<a href="#">MLG0402P4N7ST000</a>
4.7	4.6	4.7	4.8	4.9	11	14	21	22	24	<a href="#">MLG0402P4N7HT000</a>
4.7	4.6	4.7	4.8	4.9	11	14	21	22	24	<a href="#">MLG0402P4N7JT000</a>
5.1	5.0	5.1	5.2	5.3	10	13	20	21	22	<a href="#">MLG0402P5N1ST000</a>
5.1	5.0	5.1	5.2	5.3	10	13	20	21	22	<a href="#">MLG0402P5N1HT000</a>
5.1	5.0	5.1	5.2	5.3	10	13	20	21	22	<a href="#">MLG0402P5N1JT000</a>
5.6	5.5	5.7	5.8	5.9	11	14	21	22	24	<a href="#">MLG0402P5N6ST000</a>
5.6	5.5	5.7	5.8	5.9	11	14	21	22	24	<a href="#">MLG0402P5N6HT000</a>
5.6	5.5	5.7	5.8	5.9	11	14	21	22	24	<a href="#">MLG0402P5N6JT000</a>
6.2	6.1	6.3	6.4	6.6	11	14	20	21	22	<a href="#">MLG0402P6N2HT000</a>
6.2	6.1	6.3	6.4	6.6	11	14	20	21	22	<a href="#">MLG0402P6N2JT000</a>

## Measurement equipment

Product No.	Manufacturer
4291B+16196D	Keysight Technologies

\* Equivalent measurement equipment may be used.

## MLG0402P type

## L, Q FREQUENCY CHARACTERISTICS TABLE

L(nH)typ.					Q typ.					Part No.
500MHz	800MHz	1.8GHz	2.0GHz	2.4GHz	500MHz	800MHz	1.8GHz	2.0GHz	2.4GHz	
6.8	6.7	6.9	7.1	7.3	11	14	20	21	23	<a href="#">MLG0402P6N8HT000</a>
6.8	6.7	6.9	7.1	7.3	11	14	20	21	23	<a href="#">MLG0402P6N8JT000</a>
7.5	7.4	7.7	7.8	8.1	11	14	20	21	22	<a href="#">MLG0402P7N5HT000</a>
7.5	7.4	7.7	7.8	8.1	11	14	20	21	22	<a href="#">MLG0402P7N5JT000</a>
8.2	8.1	8.5	8.7	9.1	11	14	20	21	22	<a href="#">MLG0402P8N2HT000</a>
8.2	8.1	8.5	8.7	9.1	11	14	20	21	22	<a href="#">MLG0402P8N2JT000</a>
9.1	9.0	9.5	9.8	10.3	12	15	21	22	22	<a href="#">MLG0402P9N1HT000</a>
9.1	9.0	9.5	9.8	10.3	12	15	21	22	22	<a href="#">MLG0402P9N1JT000</a>
10.0	10.0	10.6	10.9	11.6	11	14	20	21	22	<a href="#">MLG0402P10NHT000</a>
10.0	10.0	10.6	10.9	11.6	11	14	20	21	22	<a href="#">MLG0402P10NJT000</a>
11.0	11.0	11.7	12.1	12.9	11	14	19	20	20	<a href="#">MLG0402P11NHT000</a>
11.0	11.0	11.7	12.1	12.9	11	14	19	20	20	<a href="#">MLG0402P11NJT000</a>
12.0	12.0	13.1	13.6	14.9	11	14	18	19	19	<a href="#">MLG0402P12NHT000</a>
12.0	12.0	13.1	13.6	14.9	11	14	18	19	19	<a href="#">MLG0402P12NJT000</a>
13.0	13.0	14.3	15.0	16.6	11	14	18	18	18	<a href="#">MLG0402P13NHT000</a>
13.0	13.0	14.3	15.0	16.6	11	14	18	18	18	<a href="#">MLG0402P13NJT000</a>
15.0	15.0	16.6	17.4	19.3	11	14	17	18	17	<a href="#">MLG0402P15NHT000</a>
15.0	15.0	16.6	17.4	19.3	11	14	17	18	17	<a href="#">MLG0402P15NJT000</a>
16.0	16.2	19.3	21.1	25.5	11	13	16	16	14	<a href="#">MLG0402P16NHT000</a>
16.0	16.2	19.3	21.1	25.5	11	13	16	16	14	<a href="#">MLG0402P16NJT000</a>
18.0	18.3	22.6	25.1	31.8	11	13	15	15	12	<a href="#">MLG0402P18NHT000</a>
18.0	18.3	22.6	25.1	31.8	11	13	15	15	12	<a href="#">MLG0402P18NJT000</a>
20.0	20.4	26.1	29.6		11	13	14	13		<a href="#">MLG0402P20NHT000</a>
20.0	20.4	26.1	29.6		11	13	14	13		<a href="#">MLG0402P20NJT000</a>
22.0	22.6	30.2	35.3		10	12	13	12		<a href="#">MLG0402P22NHT000</a>
22.0	22.6	30.2	35.3		10	12	13	12		<a href="#">MLG0402P22NJT000</a>
24.0	24.7	34.9			10	12	11			<a href="#">MLG0402P24NHT000</a>
24.0	24.7	34.9			10	12	11			<a href="#">MLG0402P24NJT000</a>
27.0	28.0	41.8			10	12	11			<a href="#">MLG0402P27NHT000</a>
27.0	28.0	41.8			10	12	11			<a href="#">MLG0402P27NJT000</a>
30.0	31.7				10	11				<a href="#">MLG0402P30NHT000</a>
30.0	31.7				10	11				<a href="#">MLG0402P30NJT000</a>
33.0	35.0				10	12				<a href="#">MLG0402P33NHT000</a>
33.0	35.0				10	12				<a href="#">MLG0402P33NJT000</a>

Measurement equipment

Product No.	Manufacturer
4291B+16196D	Keysight Technologies

\* Equivalent measurement equipment may be used.

# MLG0402P type

## L FREQUENCY CHARACTERISTICS (EXAMPLE)

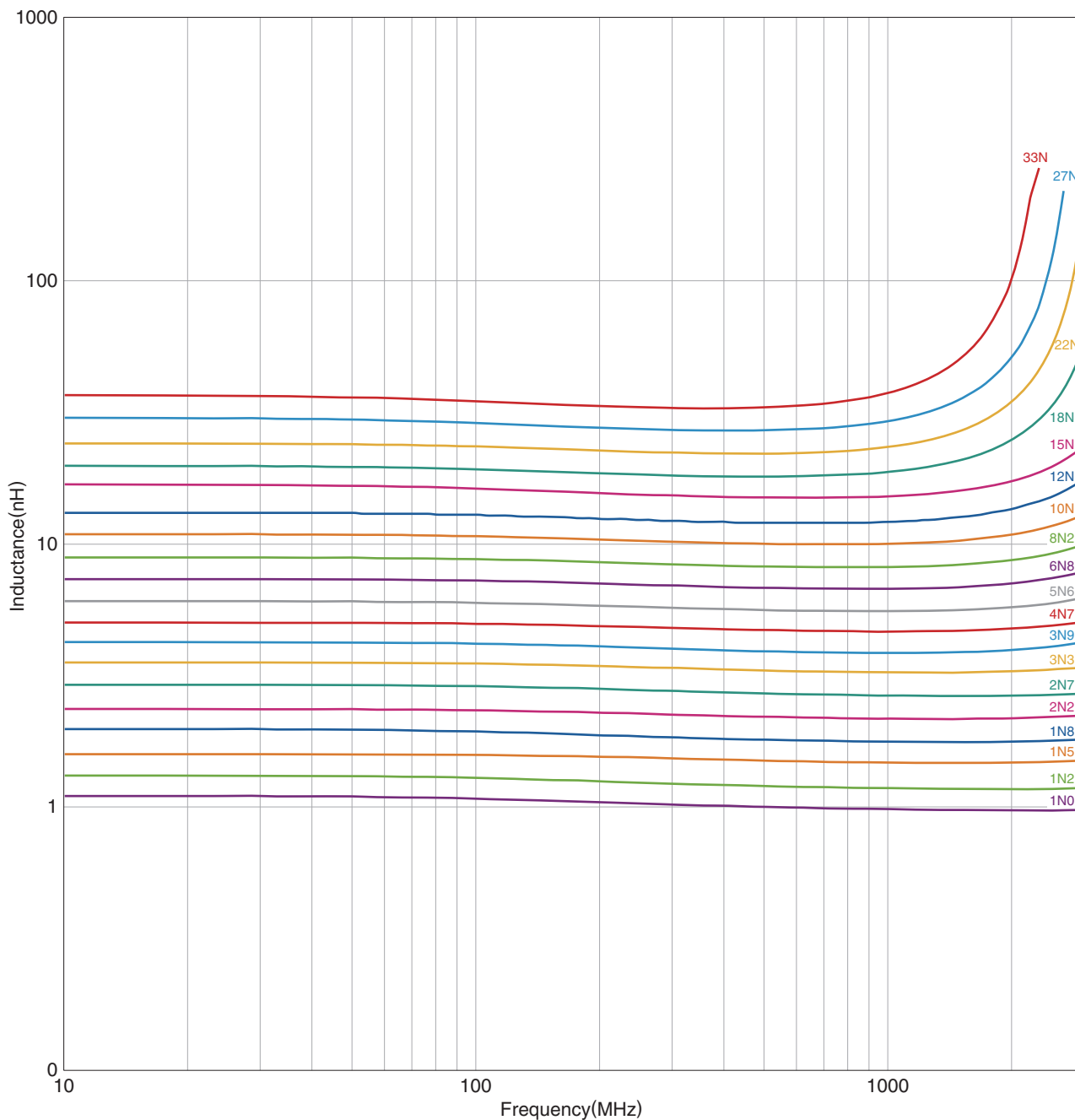

Measurement equipment

Product No.	Manufacturer
E4991A+16196D	Keysight Technologies

\* Equivalent measurement equipment may be used.

## MLG0402P type

## Q FREQUENCY CHARACTERISTICS (EXAMPLE)

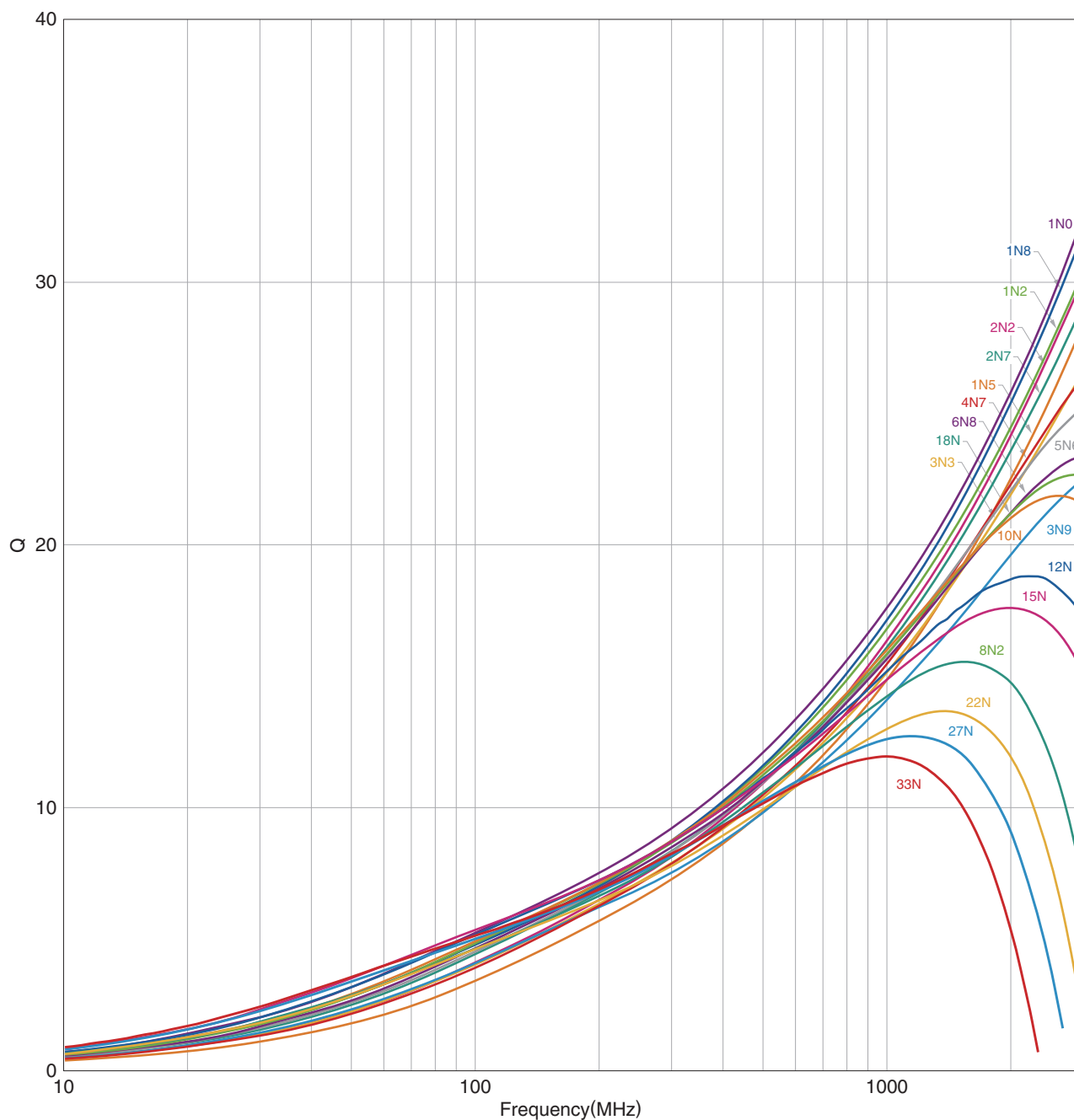

Measurement equipment

Product No.	Manufacturer
E4991A+16196D	Keysight Technologies

\* Equivalent measurement equipment may be used.

# MLG0402P type

## SHAPE & DIMENSIONS

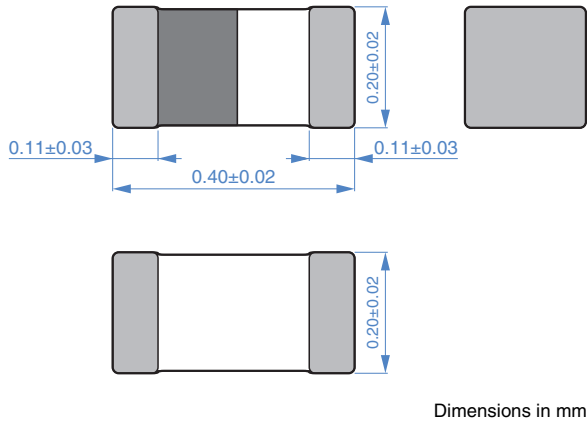

## PACKAGING STYLE

### REEL DIMENSIONS

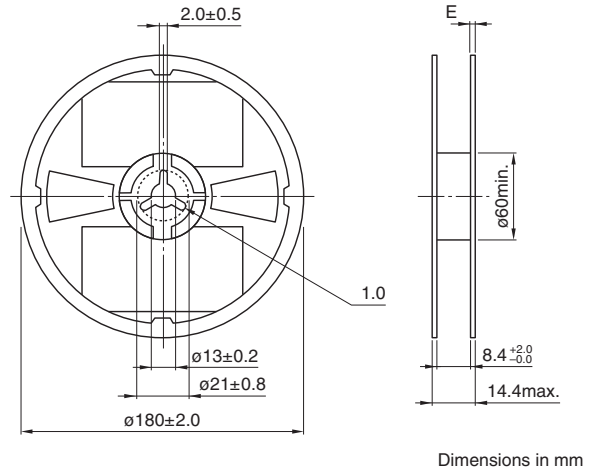

## RECOMMENDED LAND PATTERN

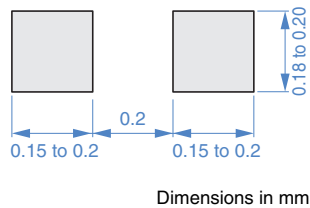

### TAPE DIMENSIONS

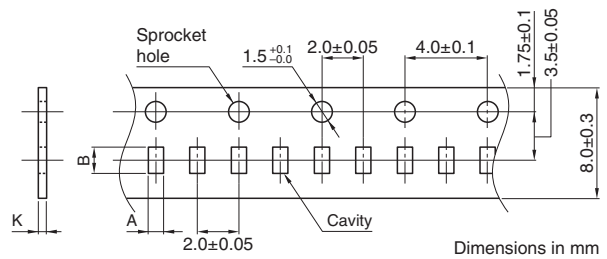

## RECOMMENDED REFLOW PROFILE

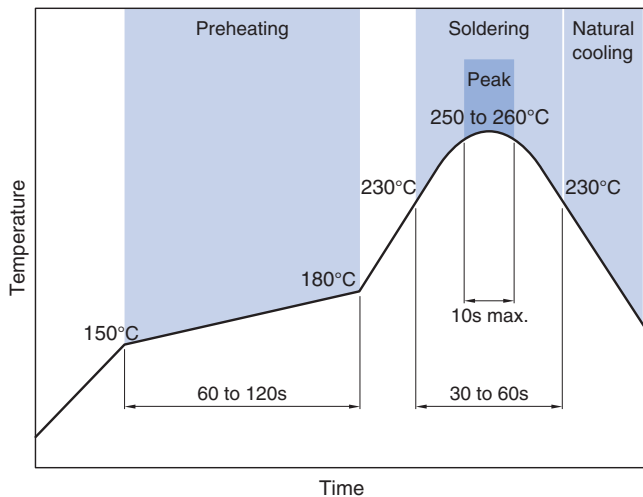

Type	A	B	K
MLG0402P	0.26±0.04	0.46±0.04	0.4 max.

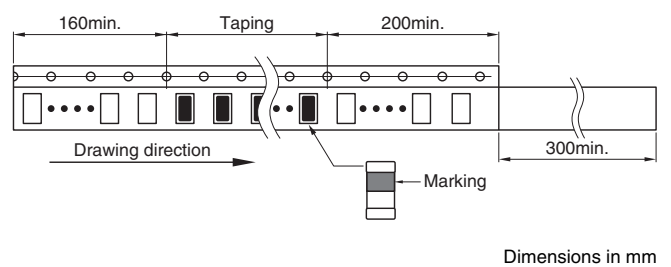

### PACKAGE QUANTITY

Package quantity	20000 pcs/reel
------------------	----------------

## TEMPERATURE RANGE, INDIVIDUAL WEIGHT

Operating temperature range	Storage temperature range*	Individual weight
-55 to +125 °C	-55 to +125 °C	0.07 mg

\* The storage temperature range is for after the assembly.

## - REMINDERS FOR USING THESE PRODUCTS -

Before using these products, be sure to request the delivery specifications.

### REMINDERS

#### 1. Introduction

This product is a multilayer inductor designed for high-frequency applications, with a lineup tailored to various purposes. By following proper handling and usage conditions, you can maximize product performance and prevent failures or safety issues.

#### 2. General Precautions

- Do not use the product beyond its rated current. Overcurrent may cause degradation of performance or damage.
- Use the product within the operating temperature range specified in the product datasheet.  
Failure to do so may lead to performance degradation or solder deterioration.
- Do not use or store in locations where there are conditions such as gas corrosion (salt, acid, alkali, etc.).
- Please use a wrist strap to discharge static electricity from the human body to the ground.
- Do not expose the products to magnets or magnetic fields.
- Do not use the product beyond the specifications described in the delivery specifications or product datasheet.

#### 3. Precautions for Mounting and Implementation

- Applying excessive external impact to the product may cause cracks or chipping.
- When embedding a printed circuit board where a chip is mounted to a set, be sure that residual stress is not given to the chip due to the overall distortion of the printed circuit board and partial distortion such as at screw tightening portions.
- For products with direction marks, the orientation of the mark may affect the set characteristics. Please verify the performance of the set in advance.
- Use the reflow soldering conditions specified in the product datasheet.
- Be sure to preheat the product before soldering.  
The temperature difference between the solder and the product during preheating should be within 150°C.
- Soldering corrections after mounting should be within the range of the conditions determined in the specifications.  
If overheated, a short circuit, performance deterioration, or lifespan shortening may occur.  
Some products do not support rework by manual soldering.
- Land pattern design affects mountability. If you change it from the recommended design, please verify it before use.
- Thermal and mechanical stress from the board can be affected by the type and amount of solder, potentially degrading performance.  
Solder Type: Use lead-free solder SAC305.  
Solder Amount: Solder with an appropriate fillet shape to avoid excessive solder.
- The original characteristics may not be achieved due to the influence of other components mounted around the product.  
In such cases, please consider changing the layout or combining inductors with different winding structures.
- The storage period is within 12 months. Be sure to follow the storage conditions (temperature: 5 to 40°C, humidity: 10 to 75% RH or less).  
If the storage period elapses, the soldering of the terminal electrodes may deteriorate.
- Avoid drops or strong impacts during transport, and avoid high temperatures caused by direct sunlight. Excessive heat can degrade the quality of packaging materials such as boxes, reels, and tapes.

#### 4. Disclaimer

These precautions are based on general usage conditions.

For detailed specifications and conditions for each product, please refer to the product datasheet and delivery specifications.

Our company assumes no responsibility for any direct or indirect damage resulting from use based on these precautions.

The contents are subject to change without notice due to improvements or other reasons.

## - SAFETY REMINDERS -

Please pay sufficient attention to the warnings for safe designing when using this products

### REMINDERS

The products listed on this catalog are intended for use in general electronic equipment (AV equipment, telecommunications equipment, home appliances, amusement equipment, computer equipment, personal equipment, office equipment, measurement equipment, industrial robots) under a normal operation and use condition.

The products are not designed or warranted to meet the requirements of the applications listed below, whose performance and/or quality require a more stringent level of safety or reliability, or whose failure, malfunction or trouble could cause serious damage to society, person or property.

If you intend to use the products in the applications listed below or if you have special requirements exceeding the range or conditions set forth in the each catalog, please contact us.

- |   |  |
|---|--|
| (1) Aerospace/aviation equipment                                  | (8) Public information-processing equipment                                  |
| (2) Transportation equipment (cars, electric trains, ships, etc.) | (9) Military equipment   |
| (3) Medical equipment   | (10) Electric heating apparatus, burning equipment                           |
| (4) Power-generation control equipment                            | (11) Disaster prevention/crime prevention equipment                          |
| (5) Atomic energy-related equipment                               | (12) Safety equipment  |
| (6) Seabed equipment  | (13) Other applications that are not considered general-purpose applications |
| (7) Transportation control equipment                              |  |

When designing your equipment even for general-purpose applications, you are kindly requested to take into consideration securing protection circuit/device or providing backup circuits in your equipment.