

Power Inductor



BWVC Series



Overview

BWVC series are an automatic assembly constructed power inductor, is shielded with magnetic resin and suitable for portable DC-DC converter application

Benefits

1. Shielded with magnetic resin
2. Various package size and wide inductance range
3. Optimize electrical characteristics by using different ferrite core figures

Applications

1. Smartphones, tablets and wearable devices, Game consoles
2. DSC, camcorders ●
3. AP Routers, STBs
4. LCD TVs, monitors and panels
5. DC/DC converters

Product Information

Series	L (mm)	W (mm)	T (mm)	Inductance (μH)
BWVC	2.0	1.6	1.0	0.24 ~ 220
	2.0	1.6	1.0	
	2.0	1.6	1.2	
	2.5	2.0	1.2	
	4.0	4.0	1.9	
	5.0	5.0	4	
	6.0	6.0	2.8	
	6.0	6.0	4.2~4.7	



BWVC00201612 Series Specification

1 Scope: This specification applies to Wire Wound Power Inductors

2 Part Numbering:

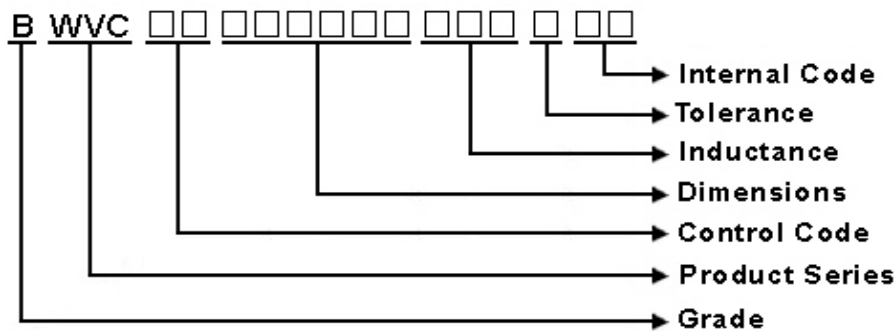

3 Rating:

Operating Temperature: - 5 5 °C ~ 1 2 5 °C (Including self - temperature rise)

Storage Temperature: - 4 0 °C ~ 1 0 5 °C

(The storage temperature range is for after the assembly)

4 Marking:

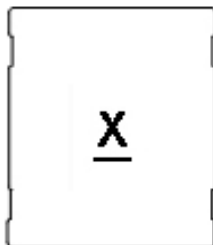

Ex Marking : C

Marking color : Black

5 Standard Testing Condition

	Unless otherwise specified	In case of doubt
Temperature	Ordinary Temperature(15 to 35°C)	20 to 30°C
Humidity	Ordinary Humidity(25 to 85% RH)	50 to 80 %RH

BWVC00201612 Series Specification

6 Configuration and Dimensions:

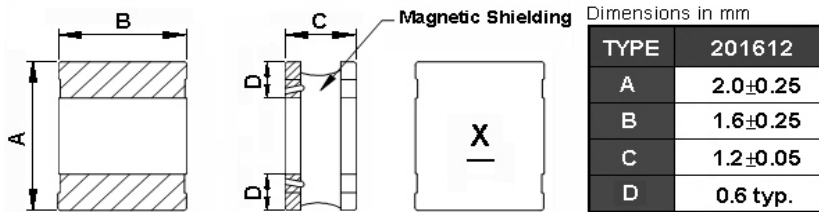

TYPE	201612
A	2.0±0.25
B	1.6±0.25
C	1.2±0.05
D	0.6 typ.

Net Weight (grms)

SIZE CODE	Net Weight (grms)
201612	0.01705 (typ).

7 Electrical Characteristics:

Part No.	Inductance (uH)	Test Freq.	RDC (Ω)±30%	Isat(mA) Typ.(Max)	Irms(mA) Typ.(Max)	Tolerance (±%)	Marking
BWVC00201612R50□00	0.5	1MHz,200mV	0.051	2600(2340)	2300(2070)	20,30	B
BWVC002016121R0□00	1.0	1MHz,200mV	0.083	1900(1710)	1800(1620)	20,30	C
BWVC002016122R2□00	2.2	1MHz,200mV	0.159	1360(1220)	1340(1200)	20,30	E
BWVC002016123R3□00	3.3	1MHz,200mV	0.22	1100(990)	1060(950)	20,30	F
BWVC002016124R7□00	4.7	1MHz,200mV	0.33	920(820)	900(810)	20,30	G
BWVC00201612100□00	10	1MHz,200mV	0.58	620(550)	580(520)	20,30	I
BWVC00201612150□00	15	1MHz,200mV	0.9	480(430)	450(400)	20,30	J
BWVC00201612220□00	22	1MHz,200mV	1.4	400(360)	400(360)	20,30	K

NOTE: □-tolerance M=±20% / T=±30%

1. Operating temperature range - 5 5°C ~ 1 2 5°C (Including self - temperature rise)
2. Isat for Inductance drop 30% from its value without current.
3. I rms for a 40°C temperature rise from 25°C ambient.
4. weight: 17.05mg typ.

BWVC00201612 Series Specification

8 BWVC00201612 Series

8.1 Construction:

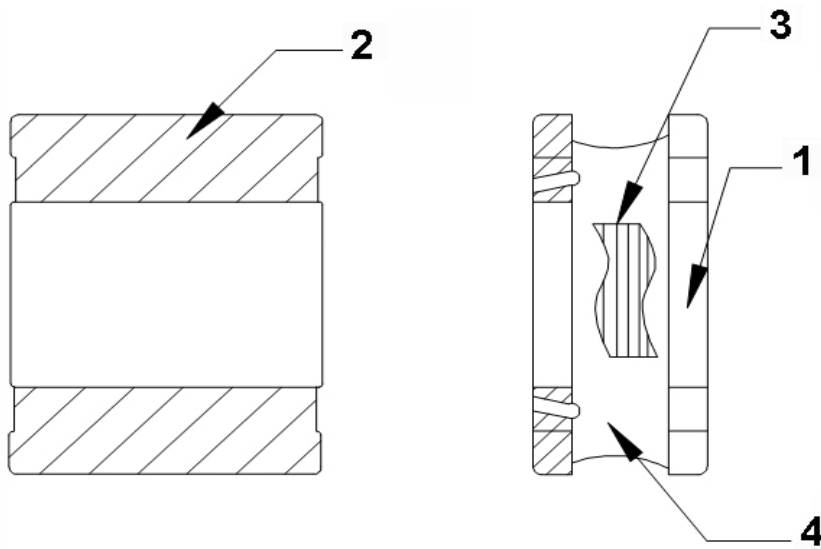

8.2 Material List:

No	Part	Material
1	CORE	FERRITE
2	TERMINAL	Ag/Cu/Ni/Sn
3	WIRE	Grade 180
4	EPOXY	Magnetic powder resin

BWVC00201612 Series Specification

9 Reliability Of Wire Wound Power Inductors

1-1.Mechanical Performance

No	Item	Specification	Test Method
1-1-1	Vibration	Chip coil shall not be damaged after tested as test method	Oscillation Frequency:10Hz to 55 Hz to 10 Hz for 1 min Total Amplitude:1.5mm Testing Time:A period of 2 hours in each of 3 mutually perpendicular directions(Total 6 hours)
1-1-2	Solderability	The wetting area of the electrode shall be at least 95% covered with new solder coating	Solder:Sn/Ag3.0/Cu0.5 per-Heating:150°C±10°C/1min to 2min solder Temperature:245°C±5°C Immersion Time:4s±1s
1-1-3	Resistance to Soldering Heat	Appearance:No damage	Solder:Sn/Ag3.0/Cu0.5 per-Heating:150°C±10°C/1min to 2min solder Temperature:260°C±5°C Immersion Time:10s±1s

1-2.Environmental Performance

No	Item	Specification	Test Method														
1-2-1	Heat Resistance	Appearance: No damage Inductance Change:within±10%	Temperature:125°C±3°C Time:1000hrs Then measured after exposure in the room Condition for 24h±2h														
1-2-2	Cold Resistance		Temperature: -55°C±3°C Time:1000hrs Then measured after exposure in the room Condition for 24h±2h														
1-2-3	Humidity		Temperature: 40°C±2°C Humidity:90%(RH) to 95%(RH) Time:1000hrs Then measures after exposure in the room Condition for 24h±2h														
1-2-4	Temperature Cycle		One cycle: <table border="1" style="width: 100%; border-collapse: collapse;"> <thead> <tr> <th>Step</th> <th>Temperature (°C)</th> <th>Time (min)</th> </tr> </thead> <tbody> <tr> <td>1</td> <td>-55±3</td> <td>30</td> </tr> <tr> <td>2</td> <td>25±2</td> <td>3</td> </tr> <tr> <td>3</td> <td>125±3</td> <td>30</td> </tr> <tr> <td>4</td> <td>25±2</td> <td>3</td> </tr> </tbody> </table>	Step	Temperature (°C)	Time (min)	1	-55±3	30	2	25±2	3	3	125±3	30	4	25±2
Step	Temperature (°C)	Time (min)															
1	-55±3	30															
2	25±2	3															
3	125±3	30															
4	25±2	3															
			Total: 100cycles Measured after exposure in the room condition for 24hrs														

BWVC00201612 Series Specification

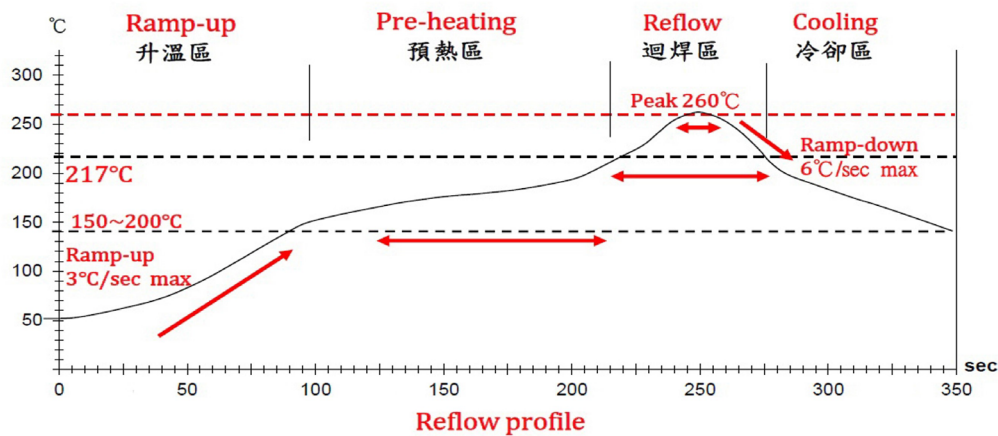

Lead-Free(LF)標準溫度分析範圍

Refer to J-STD-020C

管制項目 Item.	升温區 Ramp-up	预热區 Pre-heating	迴焊區 Reflow	Peak Temp	冷卻區 Cooling
溫度範圍 Temp.scope	R.T ~ 150°C	150°C ~ 200°C	Above 217°C	260±5°C	Peak Temp.~150°C
標準時間 Time spec.	-	60 ~ 180 sec	60 ~ 150 sec	20 ~ 40 sec	-
實際時間 Time result	-	75 ~ 100 sec	90 ~ 120 sec	20 ~ 35 sec	-

NOTE :

1. Re-flow possible times : within 2 times
2. Nitrogen adopted is recommended while in re-flow
3. Products can only be soldered with reflow

BWVC00201612 Series Specification

10 Packaging:

10.1 Packaging -Cover tape

The force for tearing off cover tape is 10 to 100 grams in the arrow direction.

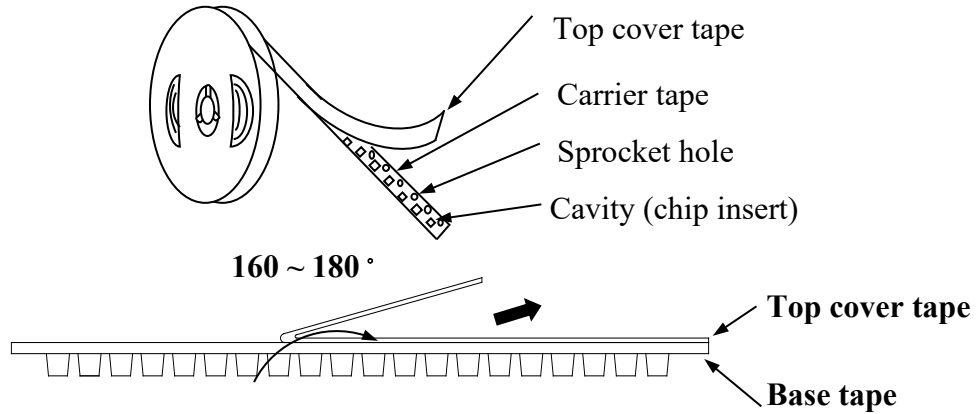

10.2 Packaging Quantity

TYPE	PCS/REEL
201612	2000

10.3 Reel Dimensions

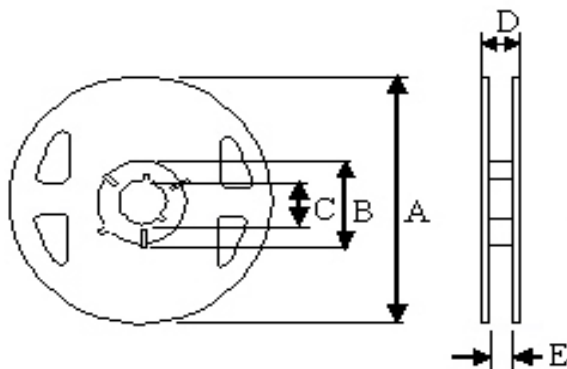

Dimensions in mm

TYPE	A	B	C	D	E
201612	180	60	13	14.4	8.4

BWVC00201612 Series Specification

10 Packaging:

10.4 Tape Dimensions in mm

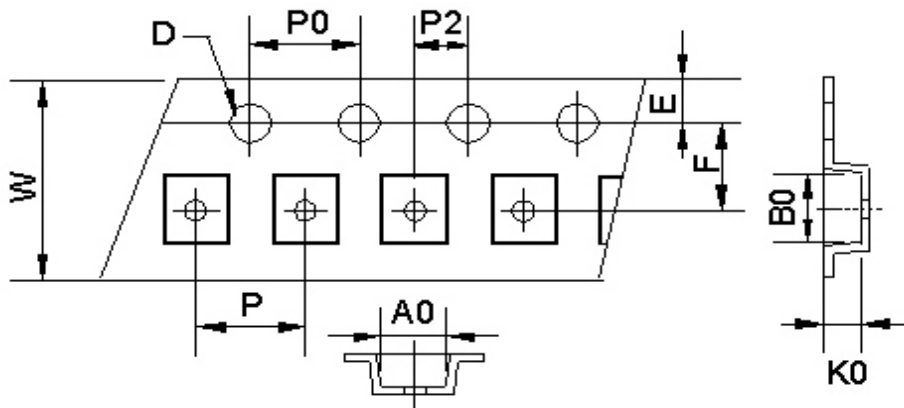

TYPE	A0	B0	K0	D	E	F	W	P	P0	P2
201612	1.9	2.2	1.3	1.55	1.75	3.5	8	4	4	2

11 Recommended Land Pattern:

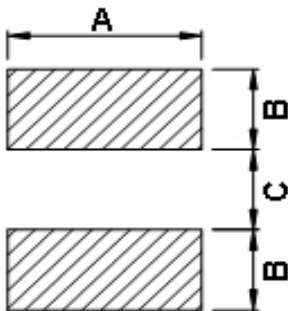

Dimensions in mm

TYPE	A	B	C
201612	1.8	0.8	0.8

12 Note:

- Please make sure that your product has been evaluated and confirmed against your specifications when our product is mounted to your product.
- Do not knock nor drop.
- All the items and parameters in this product specification have been prescribed on the premise that our product is used for the purpose, under the condition and in the environment agreed upon between you and us. You are requested not to use our product deviating from such agreement.
- The storage period is less than 12 months. Be sure to follow the storage conditions (Temperature: 5 to 40°C, Humidity: 10 to 75% RH or less).
If the storage period elapses, the soldering of the terminal electrodes may deteriorate.
- Do not use or store in locations where there are conditions such as gas corrosion (salt, acid, alkali, etc.).
- The moisture sensitivity level (MSL) of products is classified as level 1.

BWVC00201612 Series Specification

12 Note:

7. Void Appearance tolerance Limit

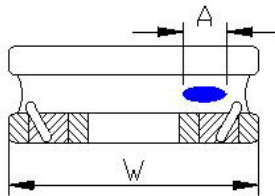

Exposed wire tolerance limit of coating resin part on product side.
The unilateral should be no more than two holes.

$$A \leq W/2 \text{ GOOD}$$

$$A > W/2 \text{ NG}$$

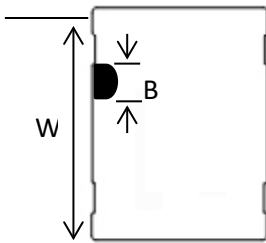

The appearance standard of the chipping size in top side.

$$B \leq W/5 \text{ GOOD}$$

$$B > W/5 \text{ NG}$$

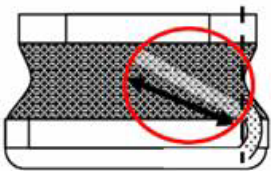

External appearance criterion for exposed wire

Exposed end of the winding wire at the side should be acceptable.

BWVC00201612 Series Specification

13 Graph: BWVC00201612 Series Graph

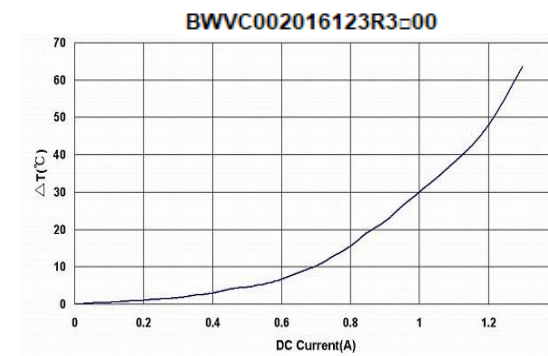
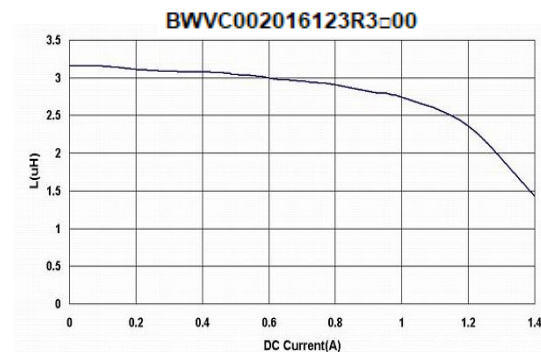
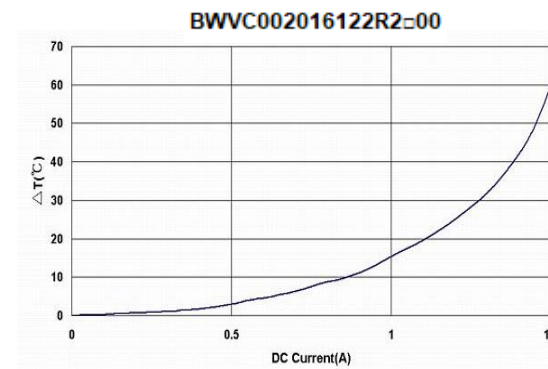
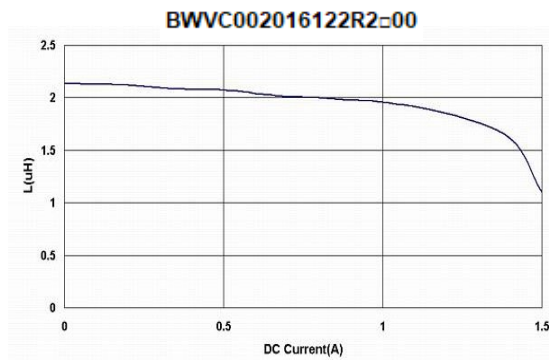
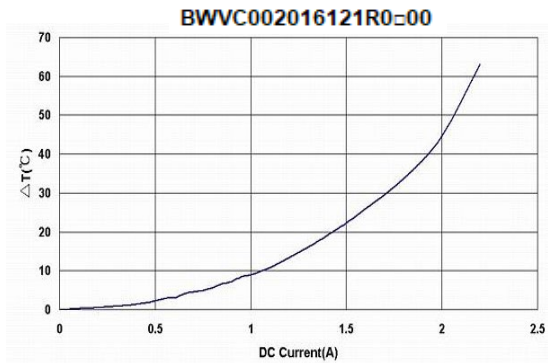
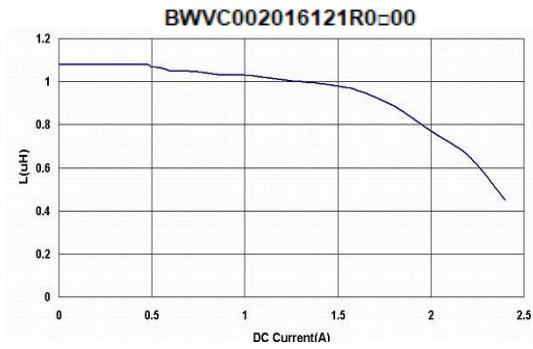
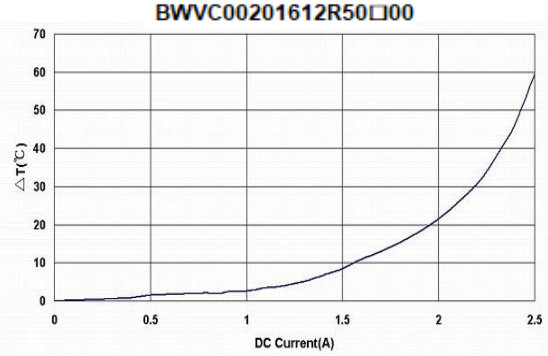
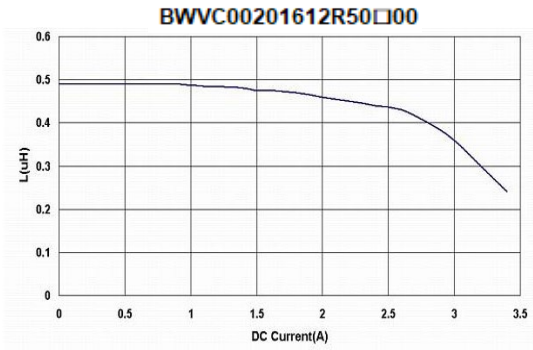

BWVC00201612 Series Specification

