

Power Inductor

BWMR Series



Overview

BWMR series are metal alloy wirewound power inductors.

Its rated current could be increased up to 35% compare to ferrite base power inductor.

Benefits

1. Constructure Low RDC and high rated current
2. Wide inductance range
3. Shielded and miniature package design

Applications

1. Smartphones, tablets and wearable devices
2. DSC, camcorders
3. DC/DC converters

Product Information

Series	L (mm)	W(mm)	T (mm)	Inductance (μH)
BWMR	2.0	1.6	1.0	0.22 ~ 100
	2.0	1.6	1.0	
	2.0	1.6	1.2	
	2.5	2.0	1.0	
	2.5	2.0	1.2	
	3.0	2.7	1.2	
	4.0	4.0	1.2	
	4.0	4.0	2.0	



BWMR00302712 Series Specification

1 Scope: This specification applies to Wire Wound Power Inductors

2 Part Numbering:

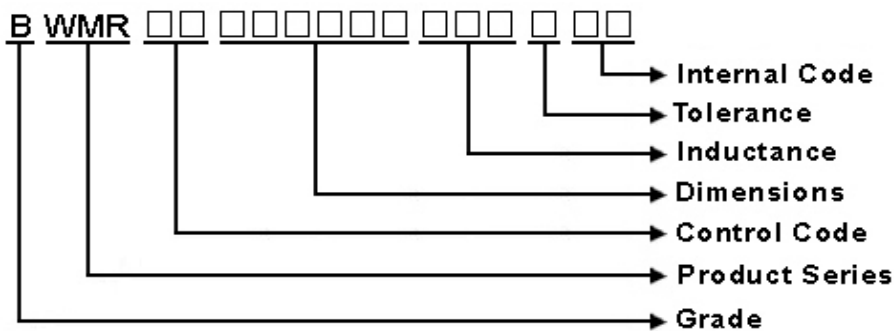

3 Rating:

Operating Temperature: - 4 0 °C ~ 1 2 5 °C (Including self - temperature rise)

Storage Temperature: - 4 0 °C ~ 1 0 5 °C

(The storage temperature range is for after the assembly)

4 Marking:

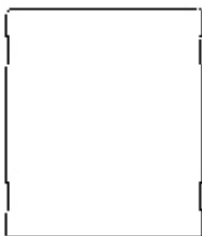

NO Marking

5 Standard Testing Condition

	Unless otherwise specified	In case of doubt
Temperature	Ordinary Temperature(15 to 35°C)	20 to 30°C
Humidity	Ordinary Humidity(25 to 85% RH)	50 to 80 %RH

BWMR00302712 Series Specification

6 Configuration and Dimensions:

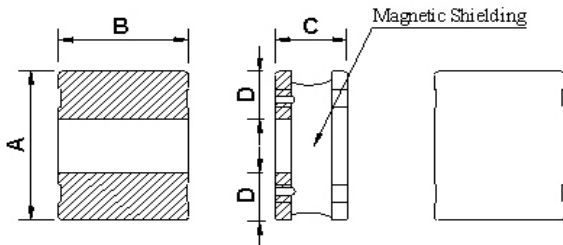

Dimensions in mm

TYPE	302712
A	3.0±0.2
B	2.7±0.2
C	1.2 Max
D	1.0 typ.

Net Weight (grams)

SIZE CODE	Net Weight (grams)
302712	0.049 (typ).

7 Electrical Characteristics:

Part No.	Inductance (uH)	Test Freq.	SRF (MHz)Min.	RDC(mΩ) Typ.(Max)	Isat(A) Typ.(Max)	Irms(A) Typ.(Max)	Tolerance (±%)
BWMR003027121R0□00	1.0	1MHz,200mV	52	54.0(64.0)	5.40(4.80)	3.00(2.70)	20,30
BWMR003027122R2□00	2.2	1MHz,200mV	28	95.0(114)	3.70(3.30)	2.30(2.00)	20,30
BWMR003027123R3□00	3.3	1MHz,200mV	25	138(165)	3.00(2.70)	1.90(1.70)	20,30
BWMR003027124R7□00	4.7	1MHz,200mV	20	195(234)	2.50(2.20)	1.50(1.30)	20,30
BWMR003027126R8□00	6.8	1MHz,200mV	16	265(318)	2.10(1.80)	1.30(1.10)	20,30
BWMR00302712100□00	10	1MHz,200mV	12	370(444)	1.70(1.50)	1.15(1.00)	20,30
BWMR00302712220□00	22	1MHz,200mV	7	795(954)	1.20(1.00)	0.70(0.63)	20,30

Note: □-tolerance M=±20% / T=±30%

- Operating temperature range -40°C~125°C (Including self - temperature rise)
- Isat for Inductance drop 30% from its value without current.
- Irms for a 40°C temperature rise from 25°C ambient.
- The part temperature (ambient + temp rise) should not exceed 125°C under worst case operating conditions.
Circuit design 125°C under worst case operating conditions. Component placement, PWB trace size and thickness, airflow and other cooling provisions all affect the part temperature. Part temperature should be verified in the end application.
- Absolute maximum voltage 25VDC

BWMR00302712 Series Specification

8 BWMR00302712 Series

8.1 Construction:

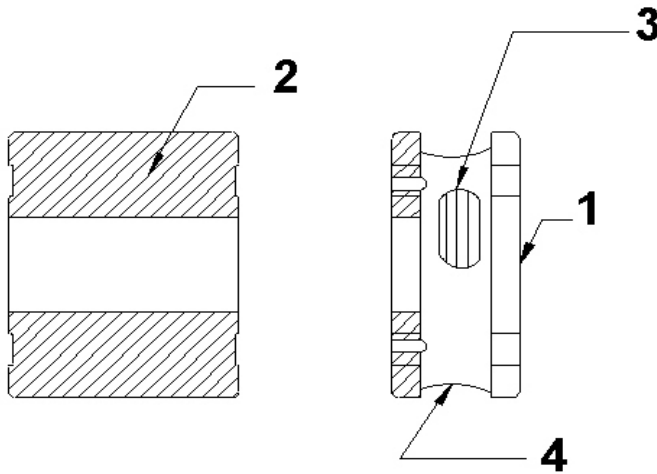

8.2 Material List:

No	Part	Material
1	CORE	Magnetic Metal
2	TERMINAL	Ag/Ni/Sn
3	WIRE	Grade 180
4	EPOXY	Magnetic powder resin

BWMR00302712 Series Specification

9 Reliability Of Wire Wound Power Inductors

1-1.Mechanical Performance

No	Item	Specification	Test Method
1-1-1	Vibration	Appearance: No damage Inductance Change:within±10%	Oscillation Frequency:10Hz to 55 Hz to 10 hZ for 1 min Total Amplitude:1.5mm Testing Time:A period of 2 hours in each of 3 mutually perpendicular directions(Total 6 hours)
1-1-2	Solderability	The wetting area of the electrode shall be at least 95% covered with new solder coating	Solder:Sn/Ag3.0/Cu0.5 per-Heating:150°C±10°C/1min to 2min solder Temperature:245°C±5°C Immersion Time:4s±1s
1-1-3	Resistance to Soldering Heat	Appearance:No damage	Solder:Sn/Ag3.0/Cu0.5 per-Heating:150°C±10°C/1min to 2min solder Temperature:260°C±5°C Immersion Time:10s±1s

1-2.Environmental Performance

No	Item	Specification	Test Method														
1-2-1	Heat Resistance	Appearance: No damage Inductance Change:within±10%	Temperature:125°C±3°C Time:500h Then measured after exposure in the room Condition for 24h±2h														
1-2-2	Cold Resistance		Temperature: -40°C±3°C Time:500h Then measured after exposure in the room Condition for 24h±2h														
1-2-3	Humidity		Temperature: 40°C±2°C Humidity:90%(RH) to 95%(RH) Time:500h Then measures after exposure in the room Condition for 24h±2h														
1-2-4	Temperature Cycle		One cycle: <table border="1" style="width: 100%; border-collapse: collapse;"> <thead> <tr> <th>Step</th> <th>Temperature (°C)</th> <th>Time (min)</th> </tr> </thead> <tbody> <tr> <td>1</td> <td>-40±3</td> <td>30</td> </tr> <tr> <td>2</td> <td>25±2</td> <td>3</td> </tr> <tr> <td>3</td> <td>125±3</td> <td>30</td> </tr> <tr> <td>4</td> <td>25±2</td> <td>3</td> </tr> </tbody> </table>	Step	Temperature (°C)	Time (min)	1	-40±3	30	2	25±2	3	3	125±3	30	4	25±2
Step	Temperature (°C)	Time (min)															
1	-40±3	30															
2	25±2	3															
3	125±3	30															
4	25±2	3															
			Total: 100cycles Measured after exposure in the room condition for 24hrs														

BWMR00302712 Series Specification

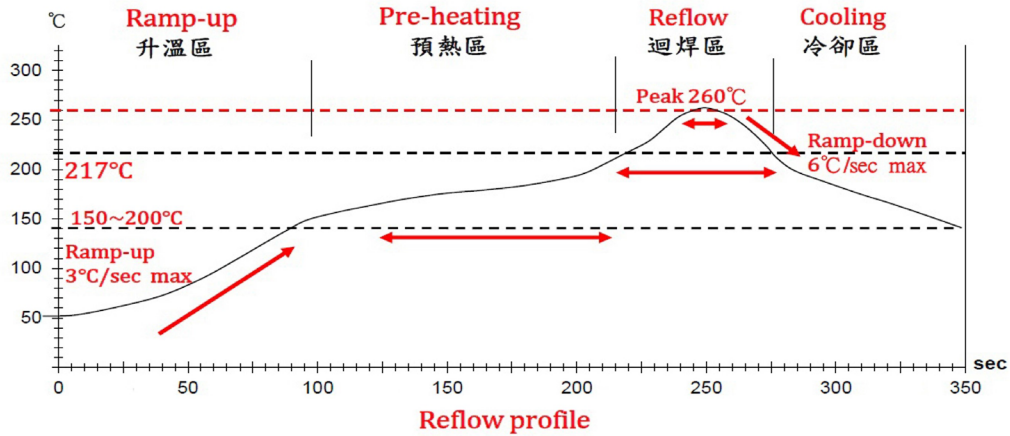

Lead-Free(LF)標準溫度分析範圍

Refer to J-STD-020C

管制項目 Item.	升温區 Ramp-up	預熱區 Pre-heating	迴焊區 Reflow	Peak Temp	冷卻區 Cooling
溫度範圍 Temp.scope	R.T ~ 150°C	150°C ~ 200°C	Above 217°C	260±5°C	Peak Temp.~150°C
標準時間 Time spec.	-	60 ~ 180 sec	60 ~ 150 sec	20 ~ 40 sec	-
實際時間 Time result	-	75 ~ 100 sec	90 ~ 120 sec	20 ~ 35 sec	-

NOTE :

1. Re-flow possible times : within 2 times
2. Nitrogen adopted is recommended while in re-flow
3. Products can only be soldered with reflow

BWMR00302712 Series Specification

10 Packaging:

10.1 Packaging -Cover Tape

The force for tearing off cover tape is 10 to 100 grams in the arrow direction.

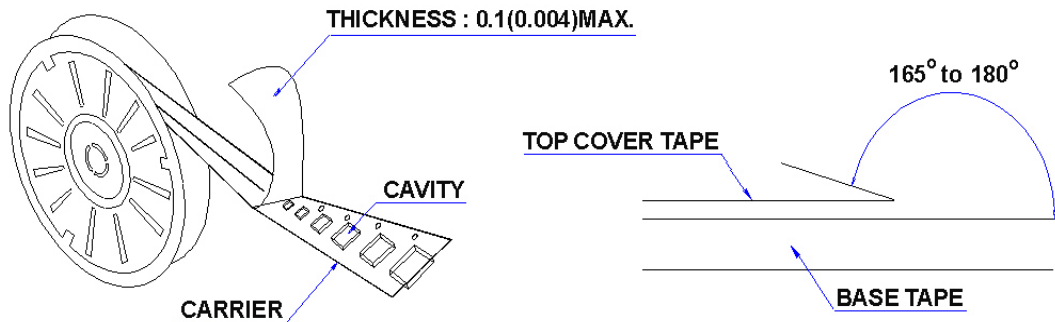

10.2 Packaging Quantity

TYPE	PCS/REEL
302712	2000

10.3 Reel Dimensions

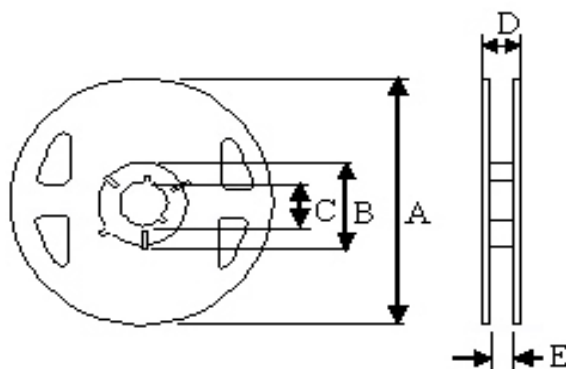

Dimensions in mm

TYPE	A	B	C	D	E
302712	180	60	13	14.4	8.4

BWMR00302712 Series Specification

10 Packaging:

10.4 Tape Dimensions in mm

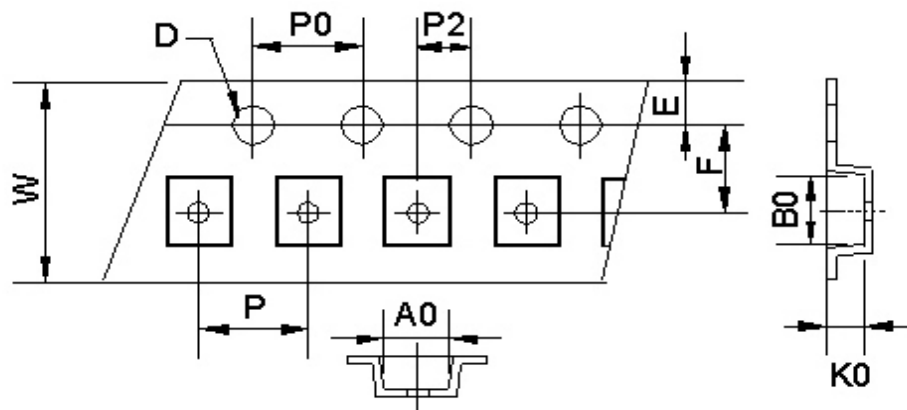

TYPE	A0	B0	K0	D	E	F	W	P	P0	P2
302712	2.90	3.20	1.35	1.55	1.75	3.5	8	4	4	2

11 Recommended Land Pattern:

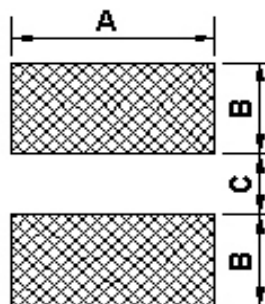

Dimensions in mm

TYPE	A	B	C
302712	2.9	1.1	1.0

12 Note:

1. Please make sure that your product has been evaluated and confirmed against your specifications when our product is mounted to your product.
2. Do not knock nor drop.
3. All the items and parameters in this product specification have been prescribed on the premise that our product is used for the purpose, under the condition and in the environment agreed upon between you and us. You are requested not to use our product deviating from such agreement.
4. The storage period is less than 12 months. Be sure to follow the storage conditions (Temperature: 5 to 40°C, Humidity: 10 to 75% RH or less).
If the storage period elapses, the soldering of the terminal electrodes may deteriorate.
5. Do not use or store in locations where there are conditions such as gas corrosion (salt, acid, alkali, etc.).
6. The moisture sensitivity level (MSL) of products is classified as level 1.

BWMR00302712 Series Specification

12 Note:

7. Void Appearance tolerance Limit

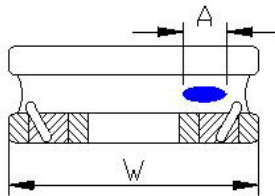

Exposed wire tolerance limit of coating resin part on product side.
The unilateral should be no more than two holes.

$$A \leq W/2 \text{ GOOD}$$

$$A > W/2 \text{ NG}$$

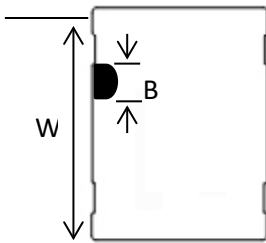

The appearance standard of the chipping size in top side.

$$B \leq W/5 \text{ GOOD}$$

$$B > W/5 \text{ NG}$$

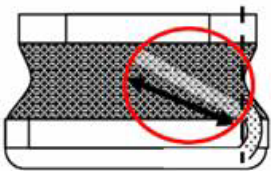

External appearance criterion for exposed wire

Exposed end of the winding wire at the side should be acceptable.

BWMR00302712 Series Specification

13 Graph: BWMR00302712 Series Graph

BWMR003027121R0□00



BWMR003027121R0□00

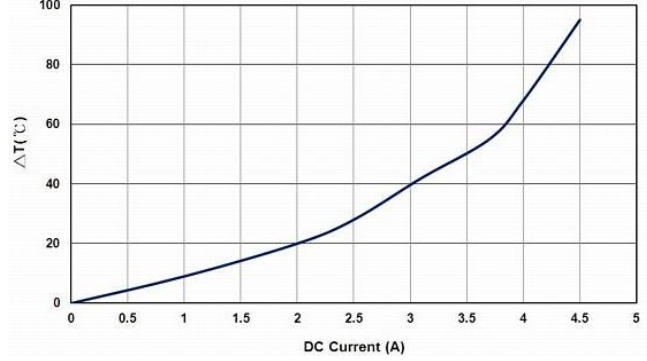

BWMR003027122R2□00

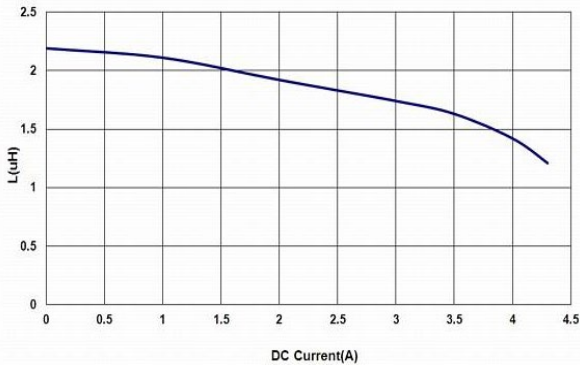

BWMR003027122R2□00

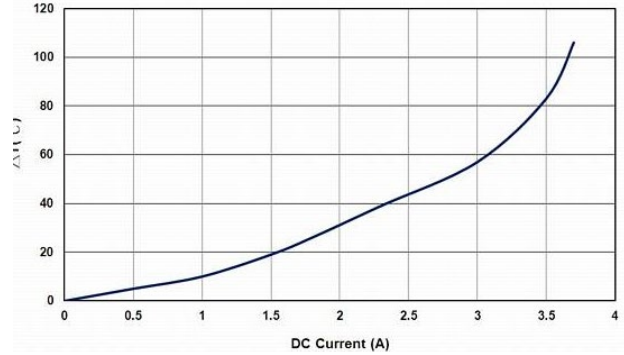

BWMR003027123R3□00

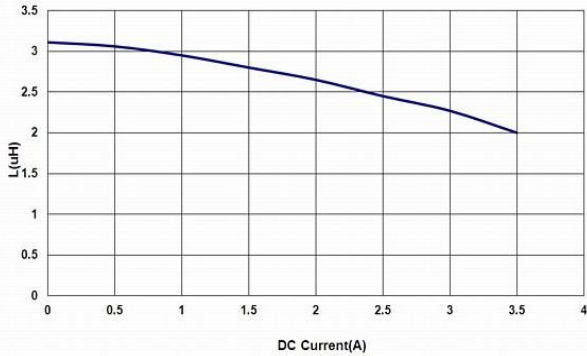

BWMR003027123R3□00

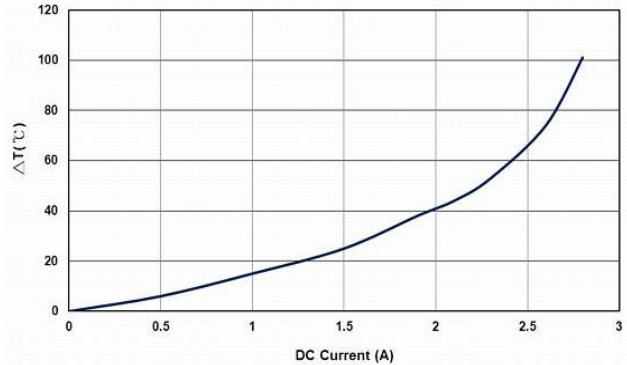

BWMR003027124R7□00

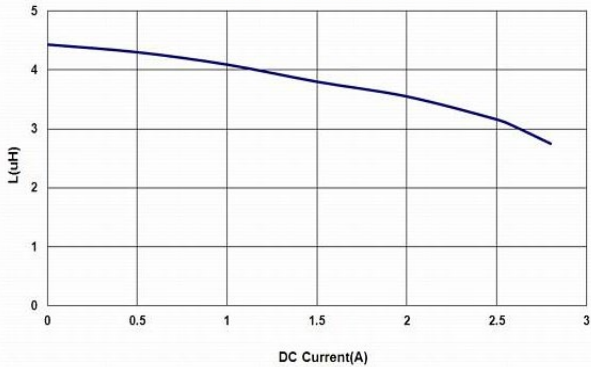

BWMR003027124R7□00

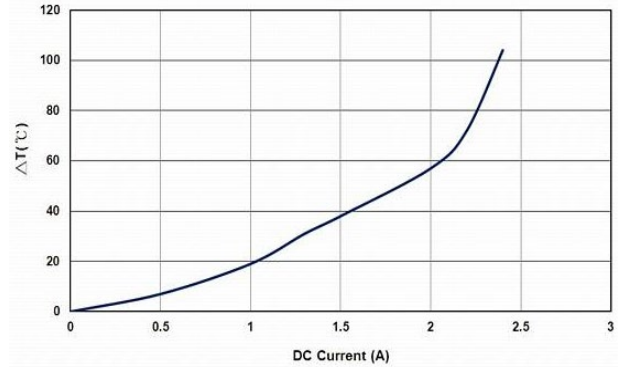

BWMR00302712 Series Specification

BWMR003027126R8□00

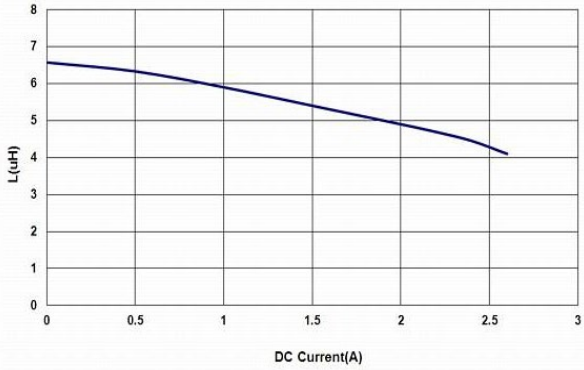

BWMR003027126R8□00

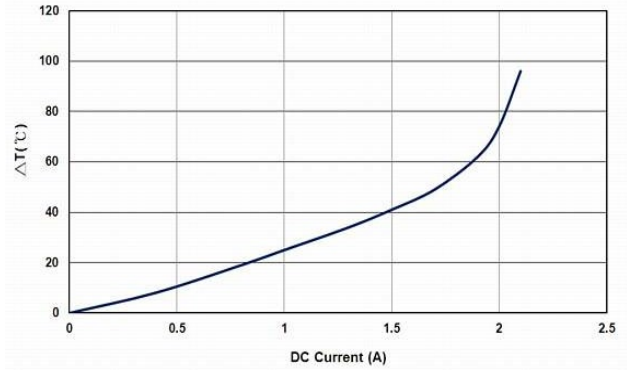

BWMR00302712100□00

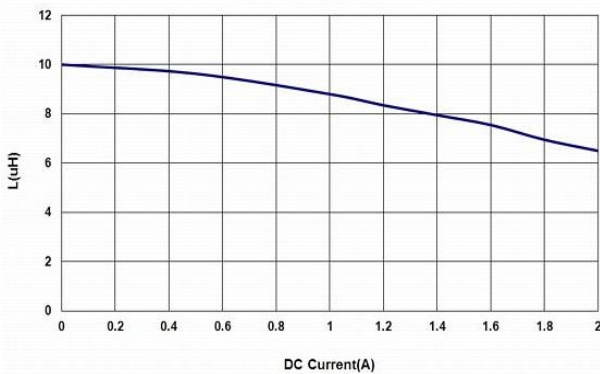

BWMR00302712100□00

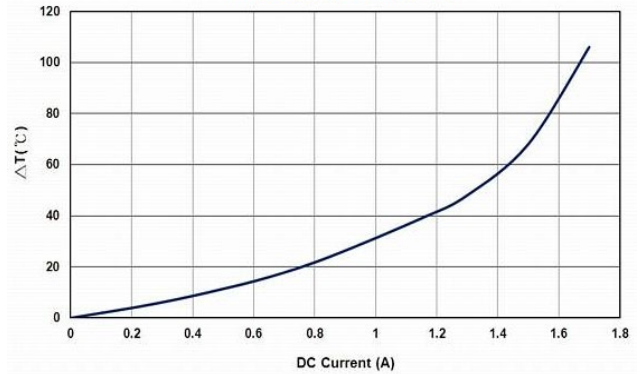

BWMR00302712220□00

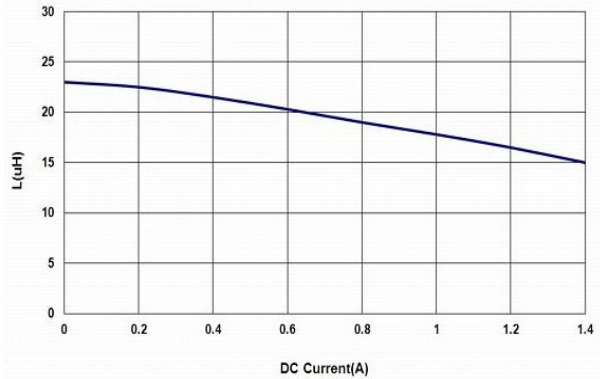

BWMR00302712220□00

