

Power Inductor



BPSC Series



Overview

Power inductors are passive electronic components used in various circuits to store energy in a magnetic field when electrical current flows through them. They are critical in filtering, energy storage, and noise suppression in power electronic systems. They are designed to handle higher currents and are optimized for minimal power loss and thermal efficiency.

Benefits

1. Ferrite SMD Shielded Type
2. No thermal aging

Applications

1. AP Routers, STBs
2. LCD TVs and monitors
3. Game consoles
4. LED lightings
5. DC/DC converters

Product Information

Series	L (mm)	W(mm)	T (mm)	Inductance (μH)
BPSC	3.2	3.2	1.55	0.47 ~ 3300
	3.2	3.2	2.0	
	4.0	4.0	1.2	
	4.0	4.0	1.8	
	4.0	4.0	3.0	
	4.7	4.7	2.0	
	4.7	4.7	3.0	
	4.7	4.7	4.0	
	5.7	5.7	2.0	
	5.7	5.7	3.0	
	6.7	6.7	3.0	
	7.3	7.3	3.4	
	7.0	7.0	4.0	
	7.3	7.3	4.5	
	8.3	8.3	4.5	
	10.3	10.5	3.1	
	10.3	10.5	4	
	10.3	10.5	5.1	
12.5	12.5	4.5		
12.5	12.5	6		
12.5	12.5	8		
12.0	12.0	10.0		



BPSC00070745 Series Specification

1 Scope: This specification applies to SMD Shielded Power Inductors

2 Part Numbering:

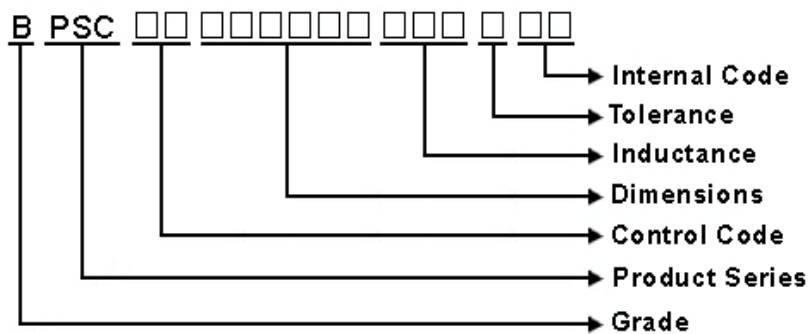

3 Rating:

Operating Temperature: $-40^{\circ}\text{C} \sim +125^{\circ}\text{C}$ (Including self temp. rise)

Storage Temperature: $-40^{\circ}\text{C} \sim +125^{\circ}\text{C}$ (For after the circuit board is mounted)

Storage Temperature: (on tape & reel): -20°C to $+40^{\circ}\text{C}$; 75% RH max.

4 Marking:



Ex Marking:100

Marking color : Black

5 Standard Testing Condition

	Unless otherwise specified	In case of doubt
Temperature	Ordinary Temperature(15 to 35°C)	20 to 30°C
Humidity	Ordinary Humidity(25 to 85% RH)	50 to 80 %RH

BPSC00070745 Series Specification

6 Configuration and Dimensions and Unit Weight:

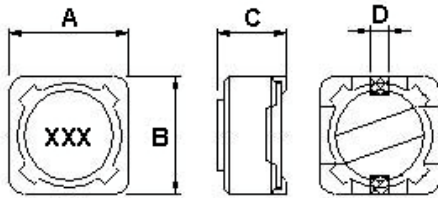

Dimensions in mm

TYPE	070745
A	7.3±0.2
B	7.3±0.2
C	4.5Max.
D	1.8

Net Weight (grms)

SIZE CODE	Net Weight (grms)
070745	0.79(Typ.)

7 Electrical Characteristics:

Part No.	Inductance (uH)	Test Freq.	RDC (Ω)Max.	Isat (A)	Tolerance	Marking
BPSC000707451R5□00	1.5	1 kHz,1 V	0.02	5	M	1R5
BPSC000707451R8□00	1.8	1 kHz,1 V	0.025	4	M	1R8
BPSC000707452R2□00	2.2	1 kHz,1 V	0.025	3.5	M,T	2R2
BPSC000707452R7□00	2.7	1 kHz,1 V	0.03	3.5	M,T	2R7
BPSC000707453R3□00	3.3	1 kHz,1 V	0.035	3.5	M,T	3R3
BPSC000707453R6□00	3.6	1 kHz,1 V	0.035	3.2	M,T	3R6
BPSC000707454R7□00	4.7	1 kHz,1 V	0.035	3	M,T	4R7
BPSC000707456R8□00	6.8	1 kHz,1 V	0.045	2.5	M	6R8
BPSC00070745100□00	10	1 kHz,1 V	0.049	1.84	M	100
BPSC00070745120□00	12	1 kHz,1 V	0.058	1.71	M	120
BPSC00070745150□00	15	1 kHz,1 V	0.081	1.47	M	150
BPSC00070745180□00	18	1 kHz,1 V	0.091	1.31	M	180
BPSC00070745220□00	22	1 kHz,1 V	0.11	1.23	M	220
BPSC00070745270□00	27	1 kHz,1 V	0.15	1.12	M	270
BPSC00070745330□00	33	1 kHz,1 V	0.17	0.96	M	330
BPSC00070745390□00	39	1 kHz,1 V	0.23	0.91	M	390
BPSC00070745470□00	47	1 kHz,1 V	0.26	0.88	M	470
BPSC00070745560□00	56	1 kHz,1 V	0.35	0.75	M	560
BPSC00070745680□00	68	1 kHz,1 V	0.38	0.69	M	680
BPSC00070745820□00	82	1 kHz,1 V	0.43	0.61	M	820
BPSC00070745101□00	100	1 kHz,1 V	0.61	0.6	M	101
BPSC00070745121□00	120	1 kHz,1 V	0.66	0.52	M	121
BPSC00070745151□00	150	1 kHz,1 V	0.88	0.46	M	151
BPSC00070745181□00	180	1 kHz,1 V	0.98	0.42	M	181
BPSC00070745221□00	220	1 kHz,1 V	1.17	0.36	K,M	221

NOTE: □-tolerance K=±10% / M=±20% / T=±30%

1. Operating temperature range - 4 0 °C ~ 1 2 5 °C(Including self - temperature rise)
2. Isat for Inductance drop 35% from its value without current.

BPSC00070745 Series Specification

Part No.	Inductance (μ H)	Test Freq.	RDC (Ω)Max.	Isat (A)	Tolerance	Marking
BPSC00070745271□00	270	1 kHz,1 V	1.64	0.34	K,M	271
BPSC00070745331□00	330	1 kHz,1 V	1.86	0.32	K,M	331
BPSC00070745391□00	390	1 kHz,1 V	2.85	0.29	K,M	391
BPSC00070745471□00	470	1 kHz,1 V	3.01	0.26	K,M	471
BPSC00070745561□00	470	1 kHz,1 V	3.62	0.23	K,M	561
BPSC00070745681□00	680	1 kHz,1 V	4.63	0.22	K,M	681
BPSC00070745821□00	820	1 kHz,1 V	5.2	0.2	K,M	821
BPSC00070745102□00	1000	1 kHz,1 V	6	0.18	K,M	102

BPSC00070745 Series Specification

8 BPSC00070745 Series

8.1 Construction:

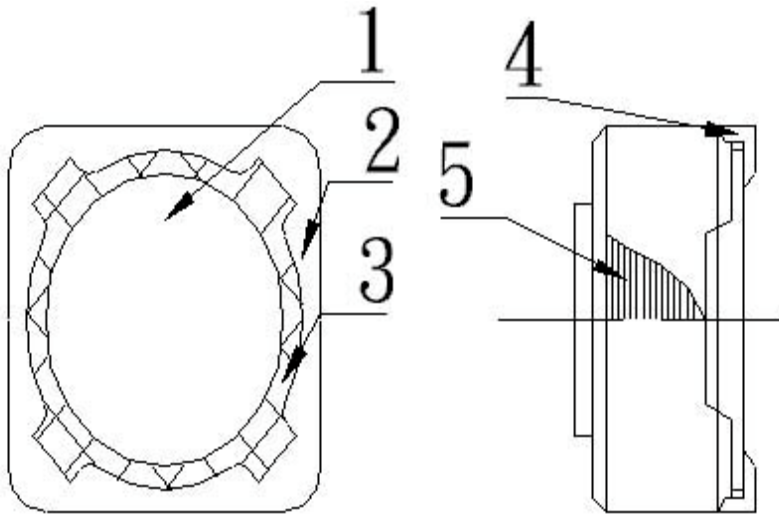

8.2 Material List:

No	Part	Material
1	CORE	FERRITE
2	CORE	FERRITE
3	EPOXY	
4	TERMINAL	TERMINAL COPPER
5	WIRE	MAGNET WIRE

BPSC00070745 Series Specification

9 Reliability Of Ferrite Wire Wound Power Inductor

1-1.Mechanical Performance

No	Item	Specification	Test Method
1-1-1	Vibration	Appearance: No damage Inductance: within $\pm 10\%$ of initial value	Test device shall be soldered on the substrate Oscillation Frequency: 10 to 55 to 10Hz for 1min Amplitude: 1.5mm Time: 2hrs for each axis (X, Y & Z), total 6hrs
1-1-2	Resistance to Soldering Heat	Appearance: No damage	Pre-heating: 150°C, 1min Solder Composition: Sn/Ag3.0/Cu0.5 Solder Temperature: 260 \pm 5°C Immersion Time: 10 \pm 1sec
1-1-3	Solder ability	The electrodes shall be at least 95% covered with new solder coating	Pre-heating: 150°C, 1min Solder Composition: Sn/Ag3.0/Cu0.5 Solder Temperature: 245 \pm 5°C Immersion Time: 4 \pm 1sec
1-1-4	Resistance to solvent	There must be no change in appearance or obliteration of marking.	Inductors must withstand 6 minutes of alcohol or water.

1-2.Environmental Performance

No	Item	Specification	Test Method															
1-2-1	Temperature Shock	Appearance: No damage Inductance: within $\pm 10\%$ of initial value	10 cycles (Air to Air) 1 cycles shall consist of: 30 minutes exposure to -55 °C 30 minutes exposure to 125 °C 15 seconds maximum transition between temperatures															
1-2-2	Temperature Cycle		One cycle: <table border="1"> <thead> <tr> <th>Step</th> <th>Temperature (°C)</th> <th>Time (min)</th> </tr> </thead> <tbody> <tr> <td>1</td> <td>-40\pm3</td> <td>30</td> </tr> <tr> <td>2</td> <td>25\pm2</td> <td>3</td> </tr> <tr> <td>3</td> <td>125\pm3</td> <td>30</td> </tr> <tr> <td>4</td> <td>25\pm2</td> <td>3</td> </tr> </tbody> </table>	Step	Temperature (°C)	Time (min)	1	-40 \pm 3	30	2	25 \pm 2	3	3	125 \pm 3	30	4	25 \pm 2	3
Step	Temperature (°C)		Time (min)															
1	-40 \pm 3		30															
2	25 \pm 2		3															
3	125 \pm 3	30																
4	25 \pm 2	3																
1-2-3	Humidity Resistance	Temperature: 40 \pm 2°C Relative Humidity: 90 ~ 95% Time: 1000hrs Measured after exposure in the room condition for 24hrs																
1-2-4	Heat Life	Temperature: 85 \pm 3°C Applied Current: Rated Current Time: 1000hrs Measured after exposure in the room condition for 24hrs																
1-2-5	Cold Resistance	Temperature: -40 \pm 3°C Time: 1000hrs Measured after exposure in the room condition for 24hrs																

BPSC00070745 Series Specification

Reflow Soldering Profile

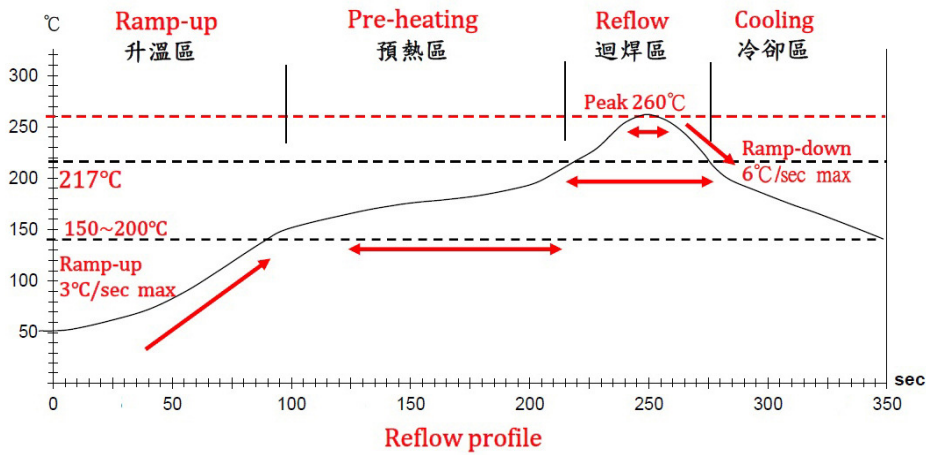

Lead-Free(LF)標準溫度分析範圍

Refer to J-STD-020C

管制項目 Item.	升温區 Ramp-up	预热區 Pre-heating	迴焊區 Reflow	Peak Temp	冷卻區 Cooling
溫度範圍 Temp.scope	R.T ~ 150°C	150°C ~ 200°C	217°C	260±5°C	Peak Temp.~150°C
標準時間 Time spec.	-	60 ~ 180 sec	60 ~ 150 sec	20 ~ 40 sec	-
實際時間 Time result	-	75 ~ 100 sec	90 ~ 120 sec	20 ~ 35 sec	-

BPSC00070745 Series Specification

10 Packaging:

10.1 Packaging -Cover Tape

The force for tearing off cover tape is 10 to 130 grams in the arrow direction.

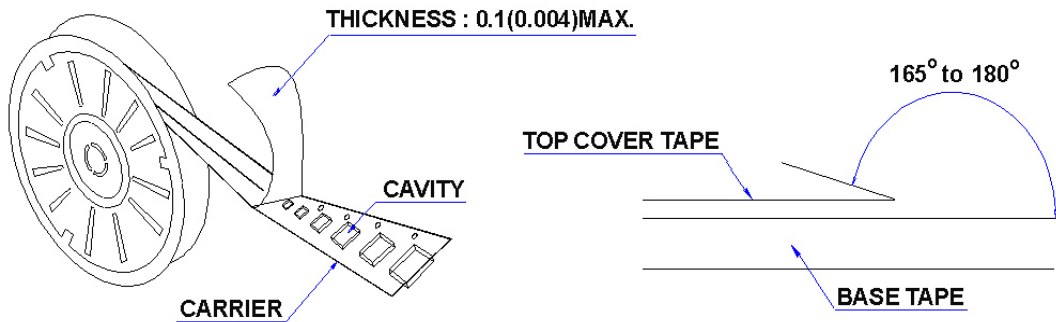

10.2 Packaging Quantity

TYPE	PCS/REEL
070745	1000

10.3 Reel Dimensions

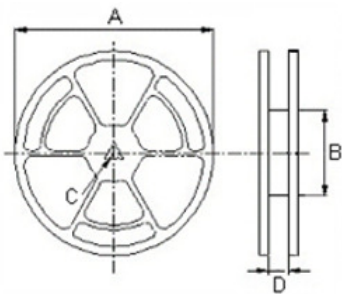

Dimensions in mm

TYPE	A	B	C	D
070745	330	100	13	16

BPSC00070745 Series Specification

10 Packaging:

10.4 Tape Dimensions in mm

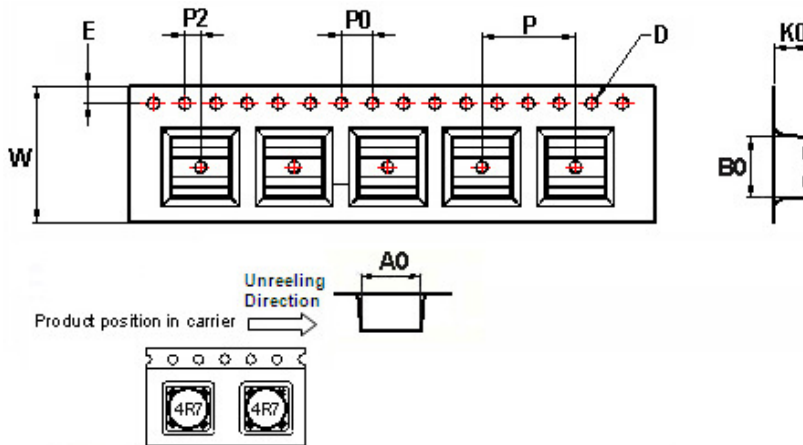

TYPE	A0	B0	K0	D	E	W	P	P0	P2
070745	7.6	7.6	5.0	1.55	1.75	16	12	4	2

11 Recommended Land Pattern:

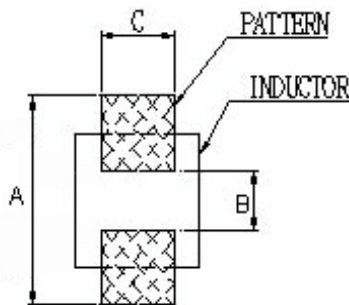

Dimensions in mm

TYPE	A	B	C
070745	8.4	4.4	2.2

12 Note:

1. Please make sure that your product has been evaluated and confirmed against your specifications when our product is mounted to your product.
2. Do not knock nor drop.
3. All the items and parameters in this product specification have been prescribed on the premise that our product is used for the purpose, under the condition and in the environment agreed upon between you and us. You are requested not to use our product deviating from such agreement.
4. Please keep the distance between transformer/coil and other components (refer to the standard IEC 950)
5. The moisture sensitivity level (MSL) of products is classified as level 1.

BPSC00070745 Series Specification

13 Graph:

BPSC000707451R5□00

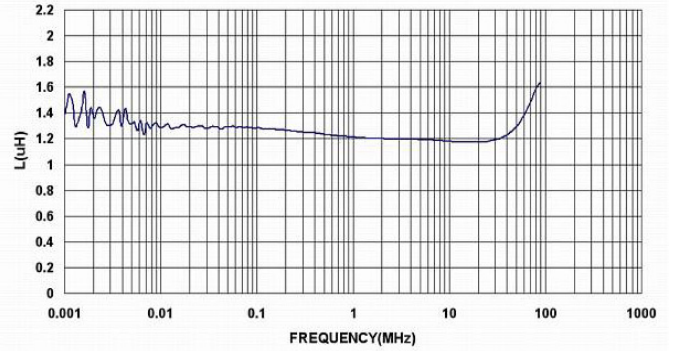

BPSC000707451R8□00

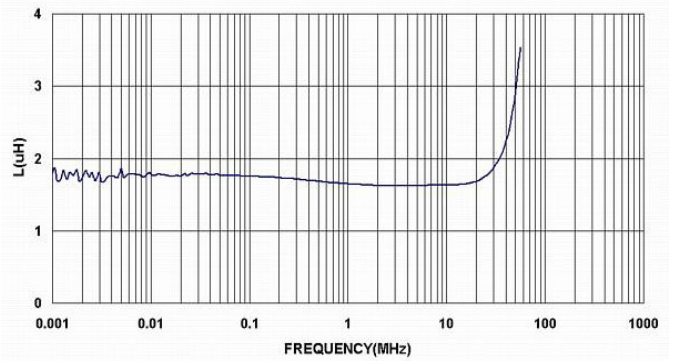
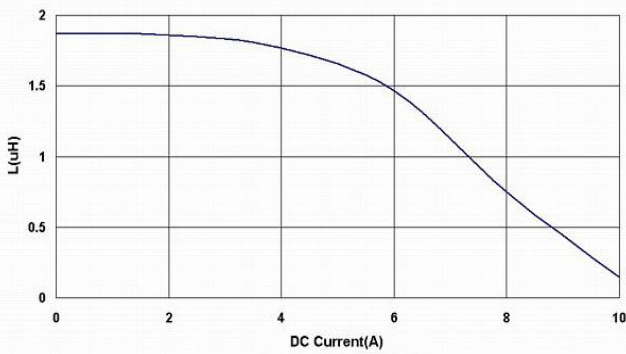

BPSC000707452R2□00

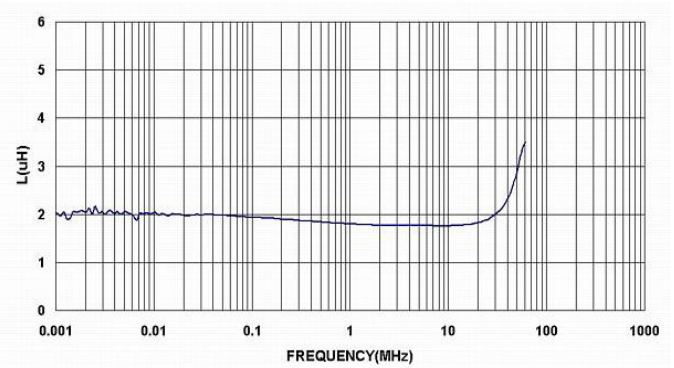
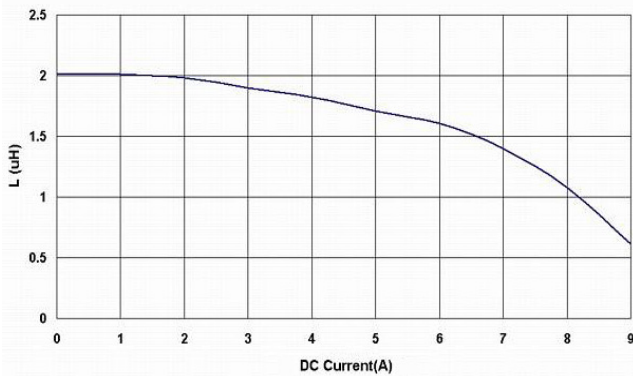

BPSC000707452R7□00

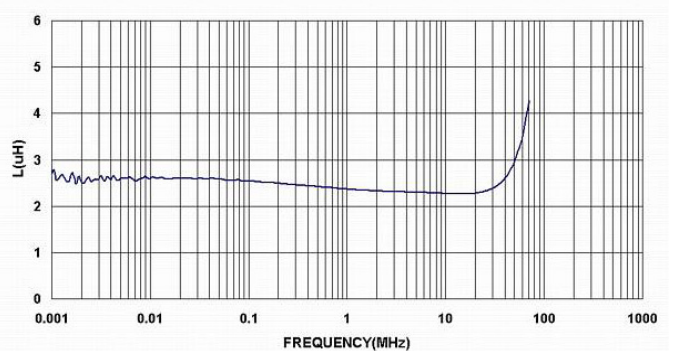

BPSC00070745 Series Specification

13 Graph:

BPSC000707453R3□00

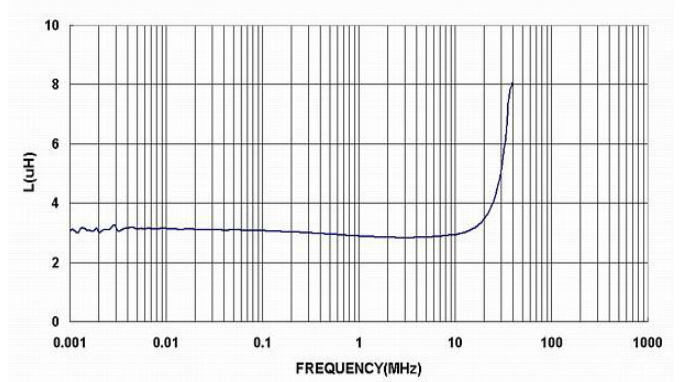
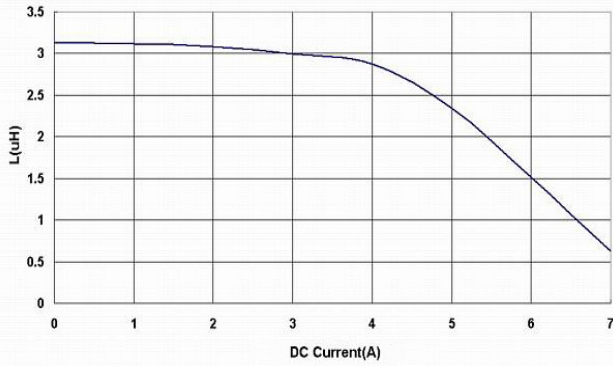

BPSC000707454R7□00

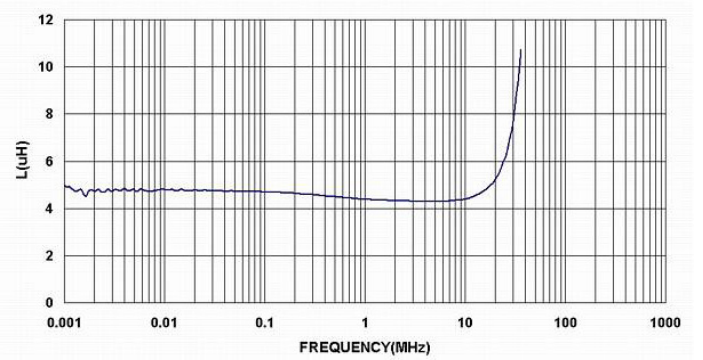
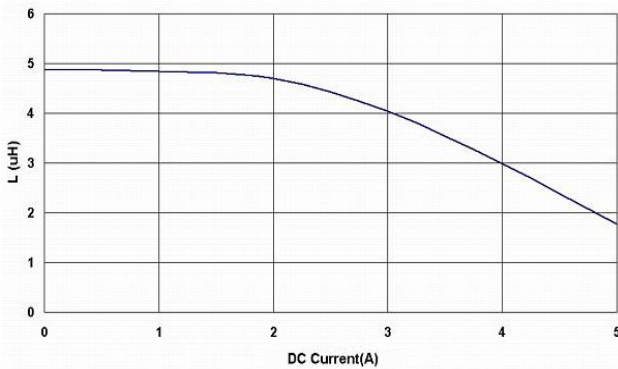

BPSC000707456R8□00

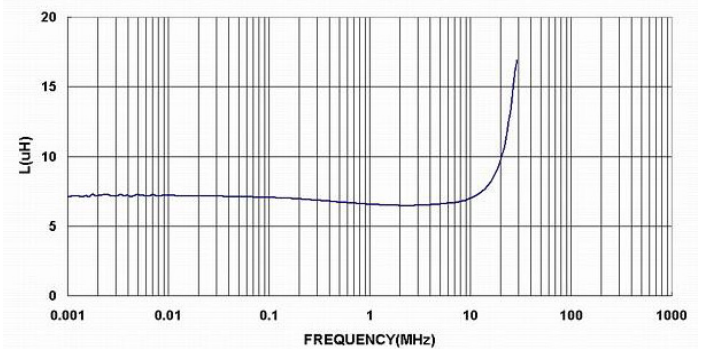
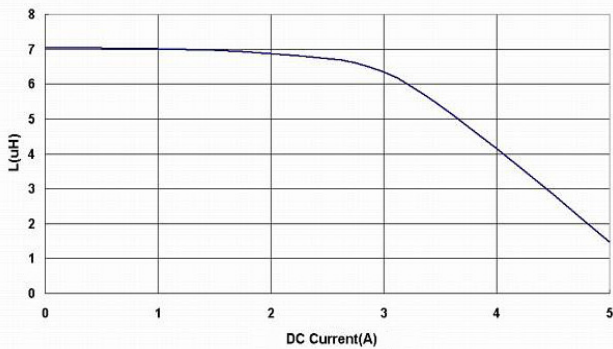

BPSC00070745102□00

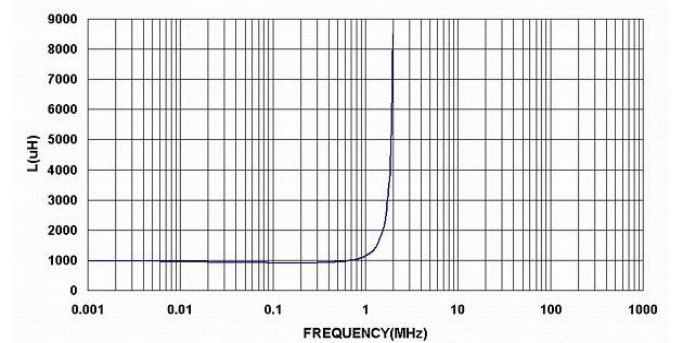
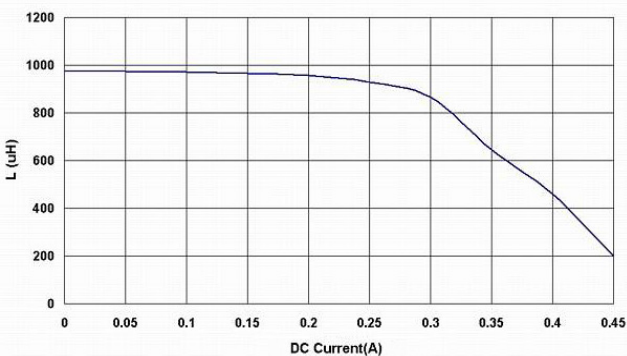

BPSC00070745 Series Specification

13 Graph:

BPSC00070745100□00

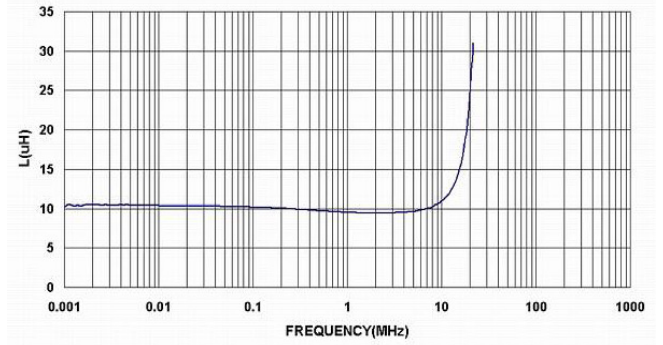
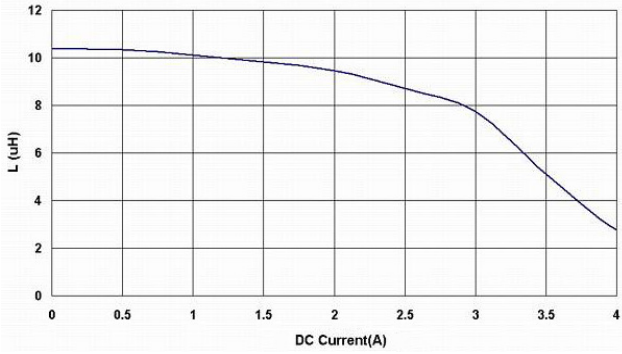

BPSC00070745120□00

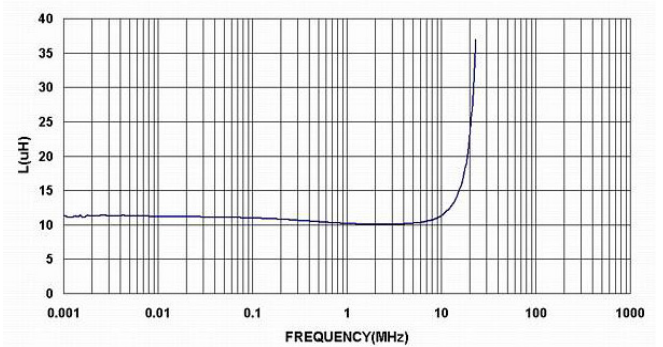
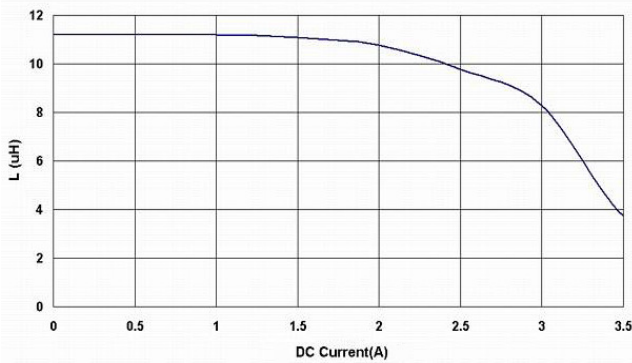

BPSC00070745150□00

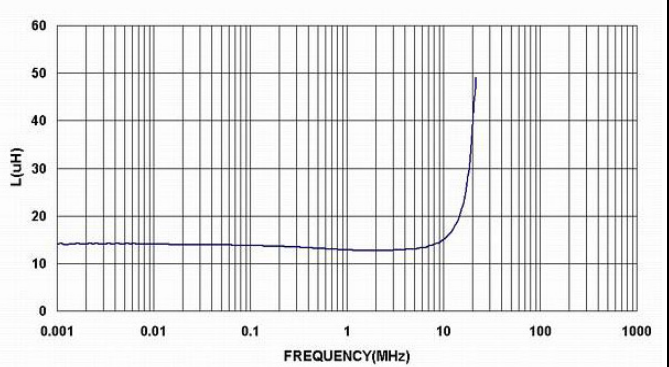
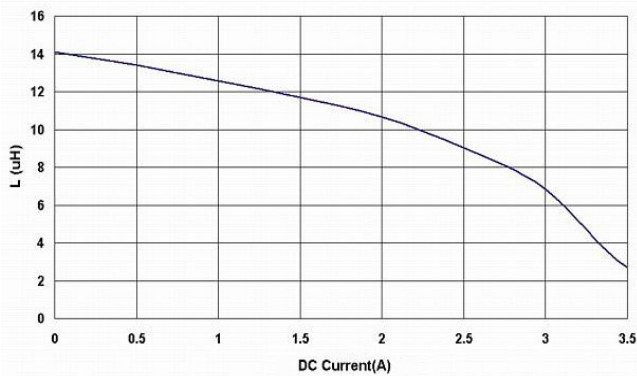

BPSC00070745180□00

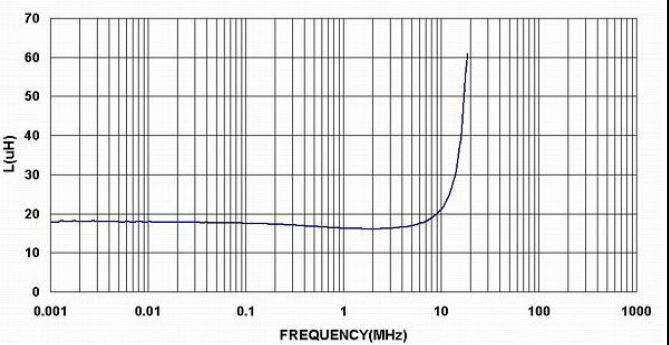
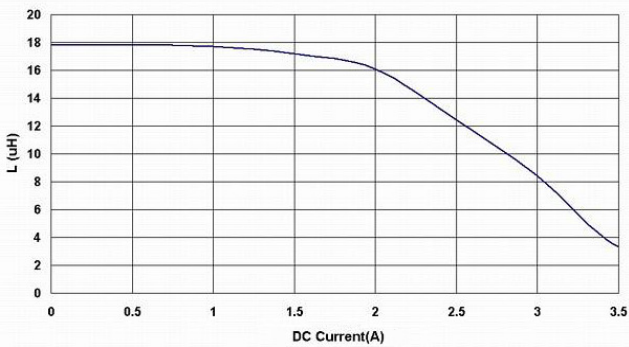

BPSC00070745 Series Specification

13 Graph:

BPSC00070745220□00

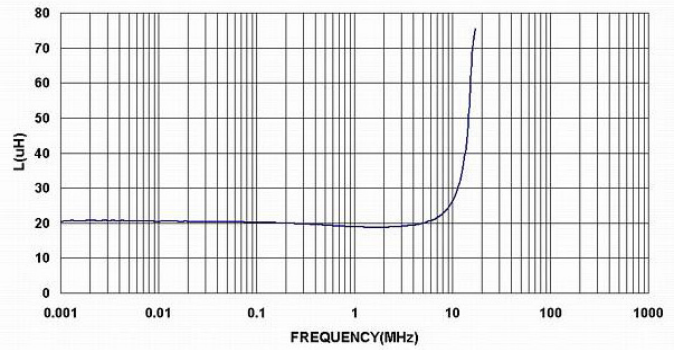
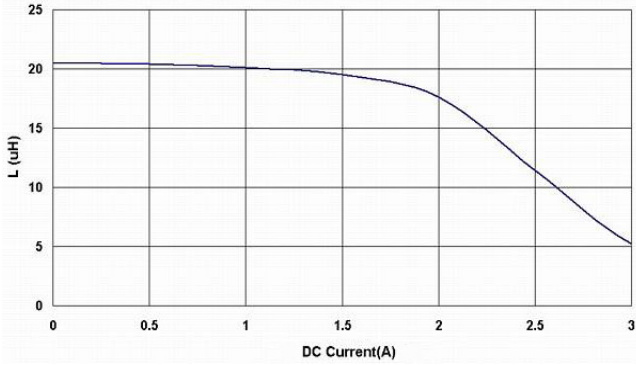

BPSC00070745270□00

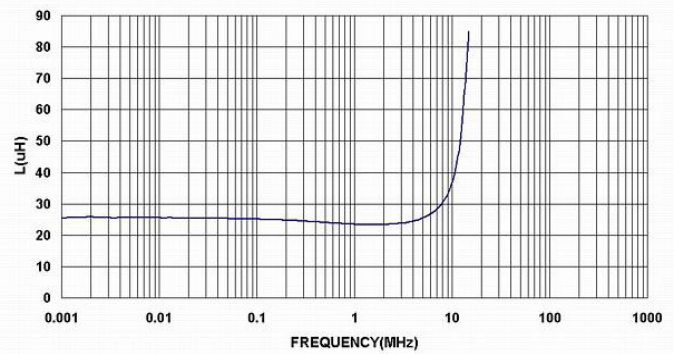
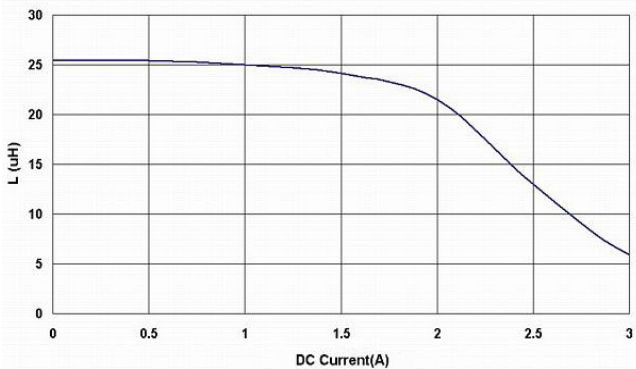

BPSC00070745330□00

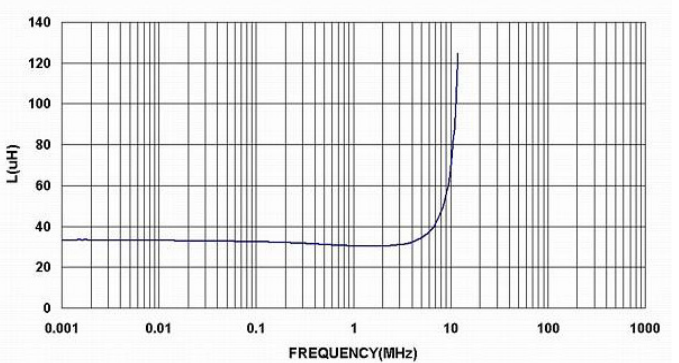
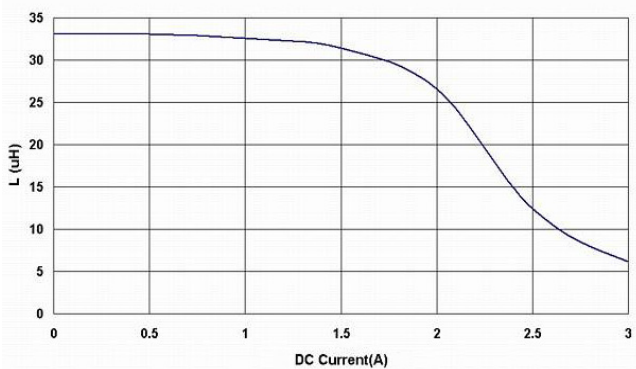

BPSC00070745390□00

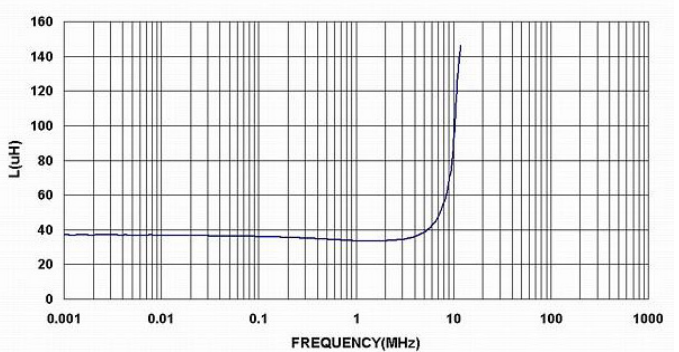
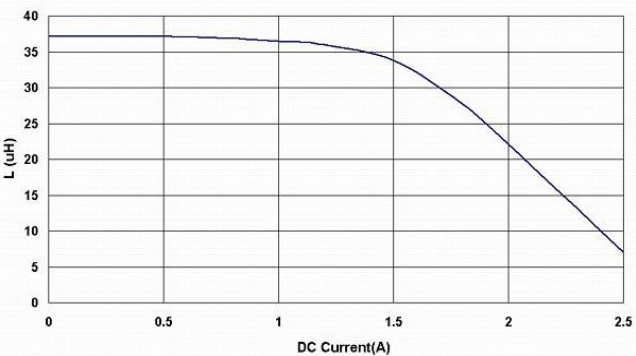

BPSC00070745 Series Specification

13 Graph:

BPSC00070745470□00

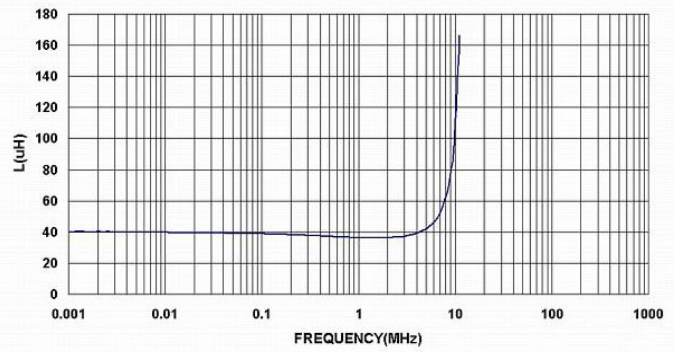
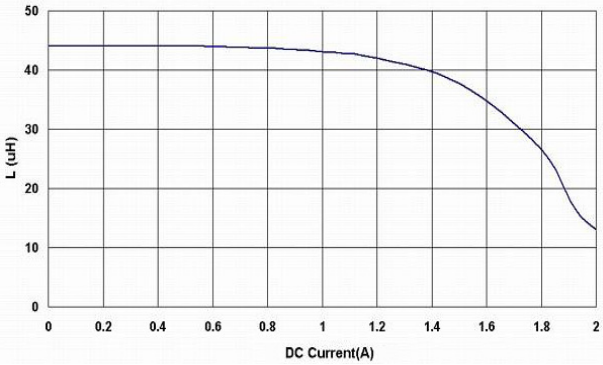

BPSC00070745560□00

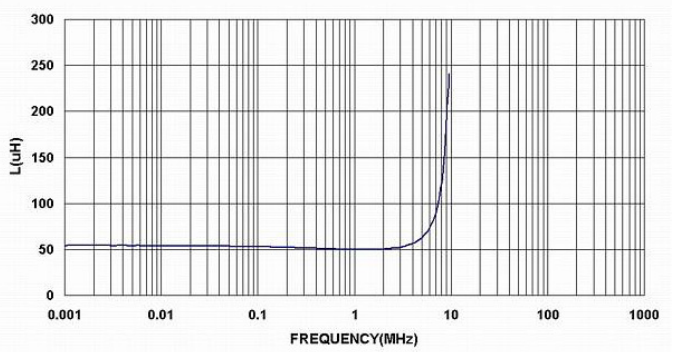
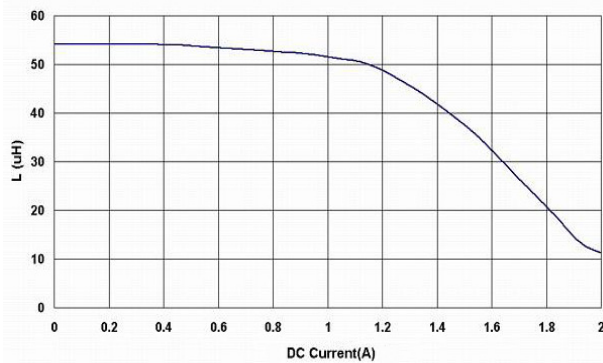

BPSC00070745680□00

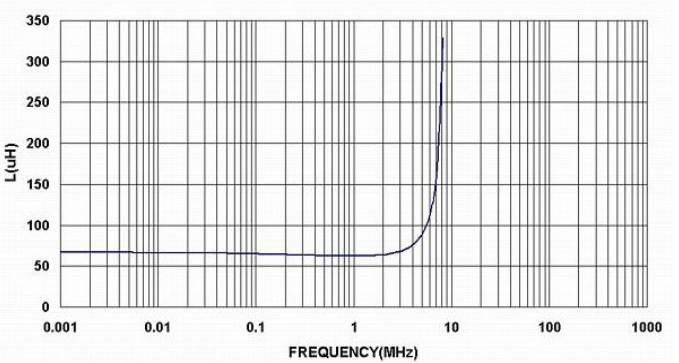
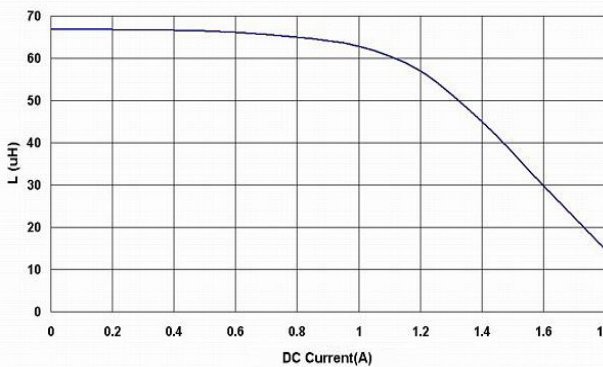

BPSC00070745820□00

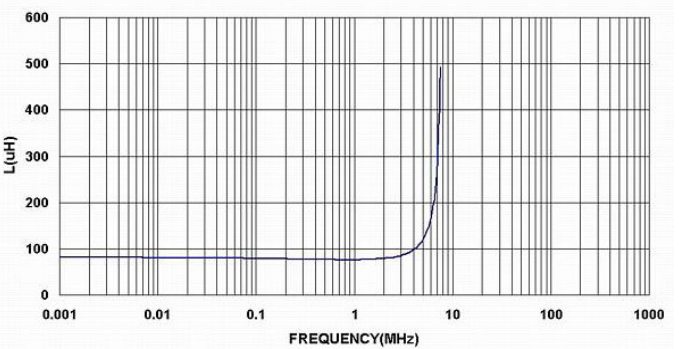
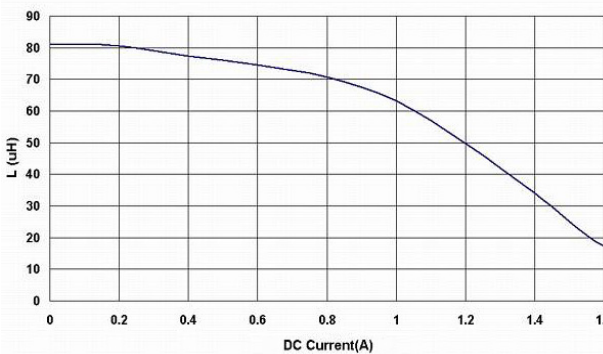

BPSC00070745 Series Specification

13 Graph:

BPSC00070745101□00

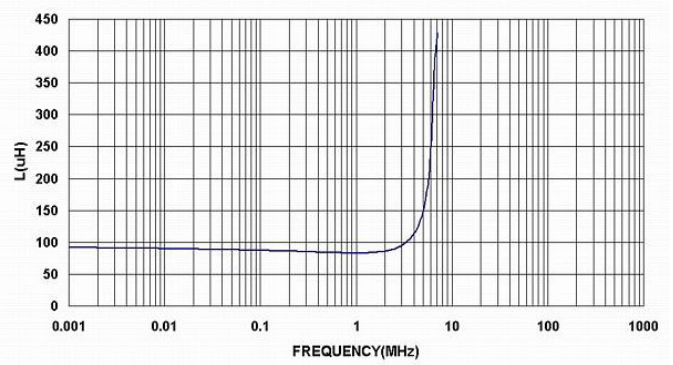
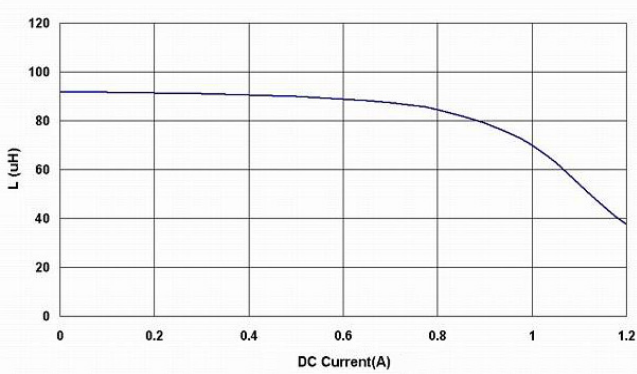

BPSC00070745121□00

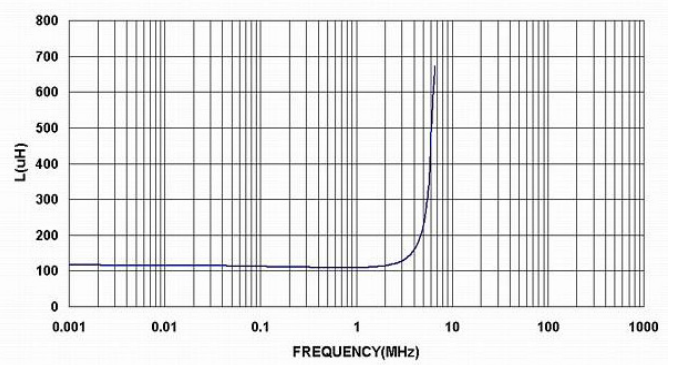
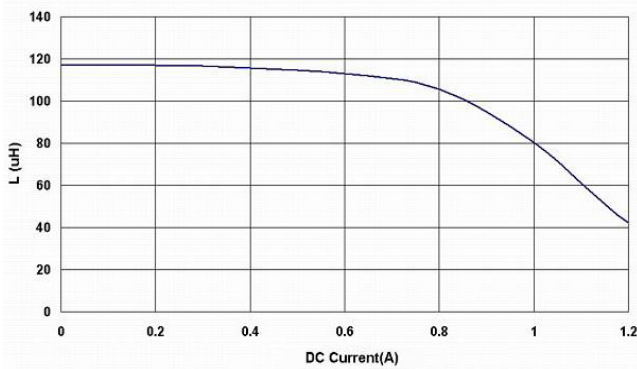

BPSC00070745151□00

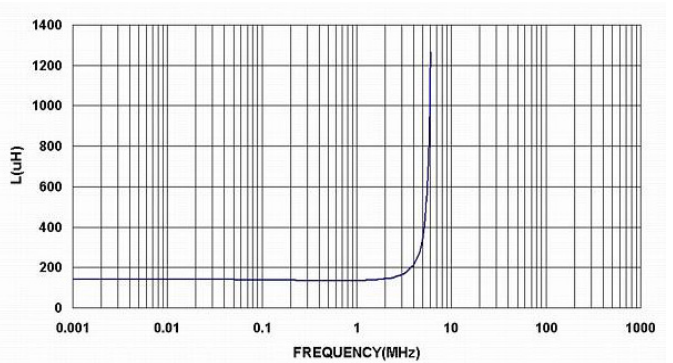
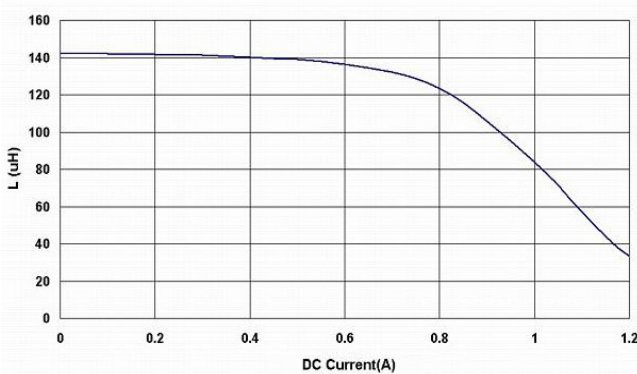

BPSC00070745181□00

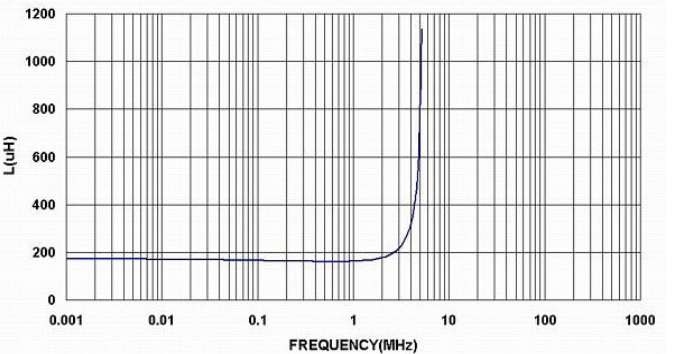
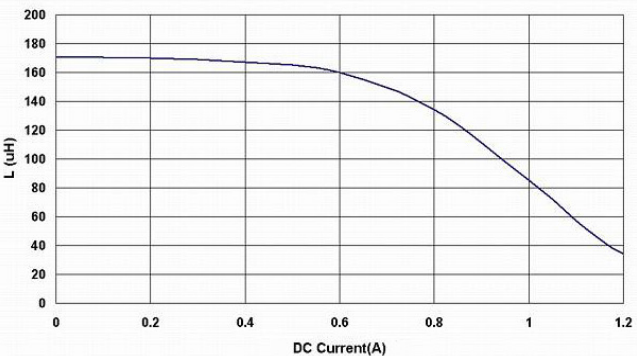

BPSC00070745 Series Specification

13 Graph:

BPSC00070745221□00

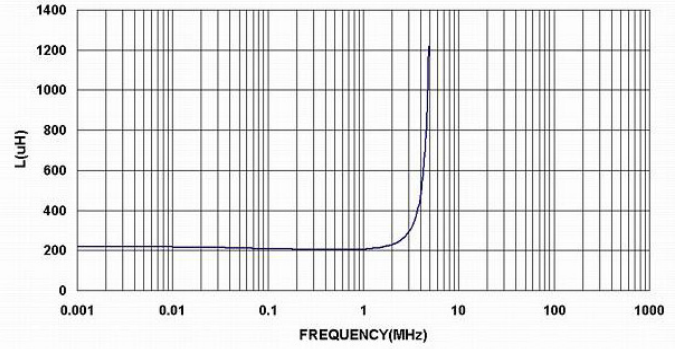
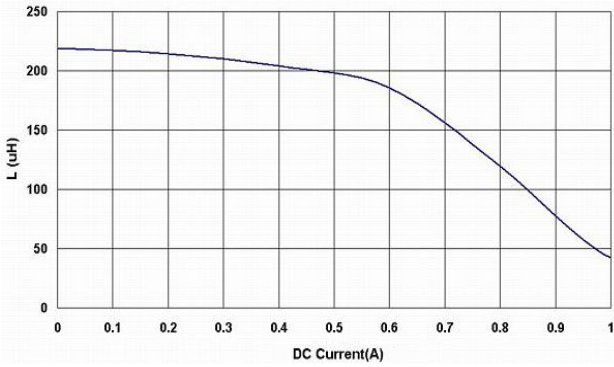

BPSC00070745271□00

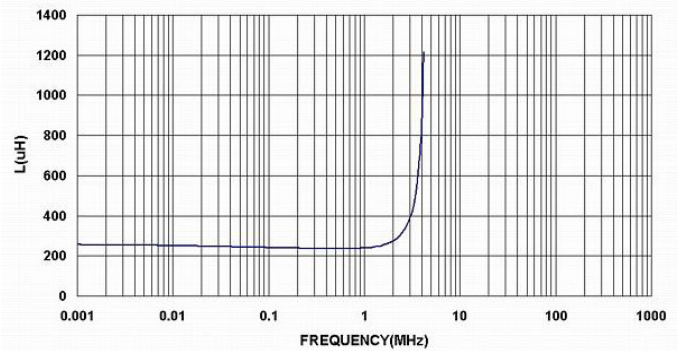
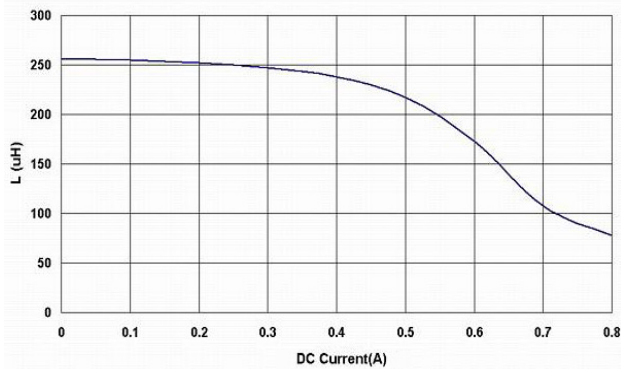

BPSC00070745331□00

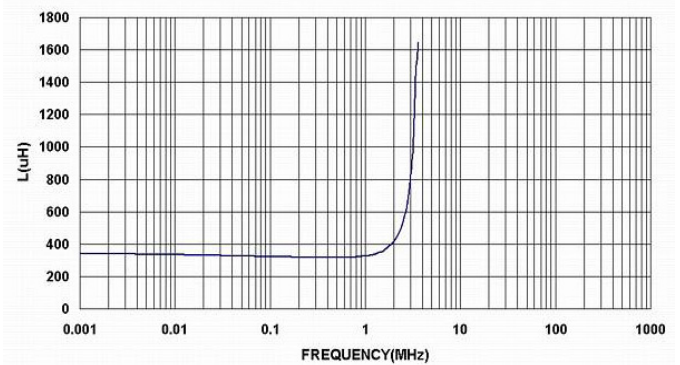
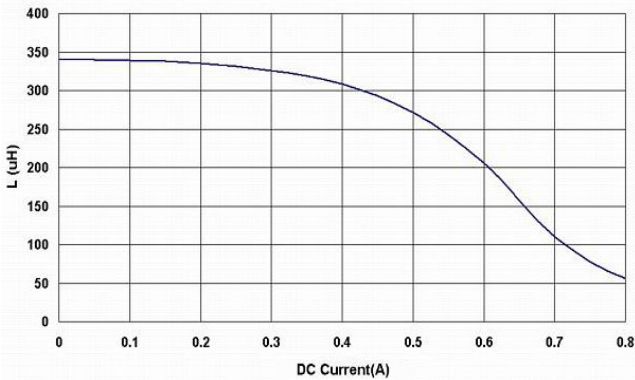

BPSC00070745391□00

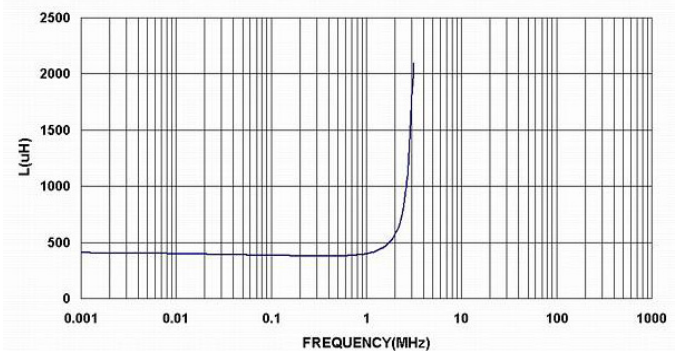
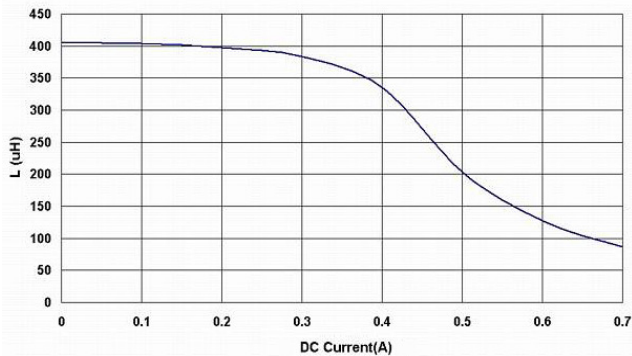

BPSC00070745 Series Specification

13 Graph:

BPSC00070745471□00

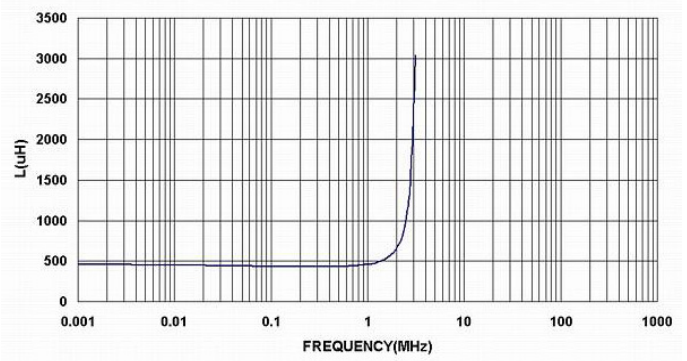
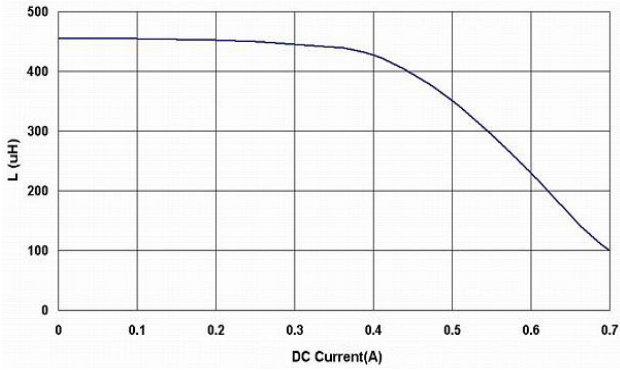

BPSC00070745561□00

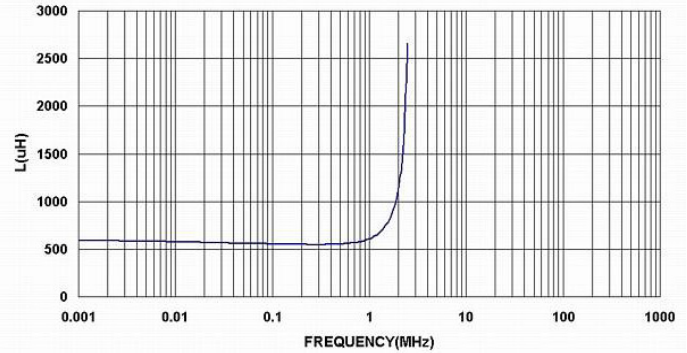
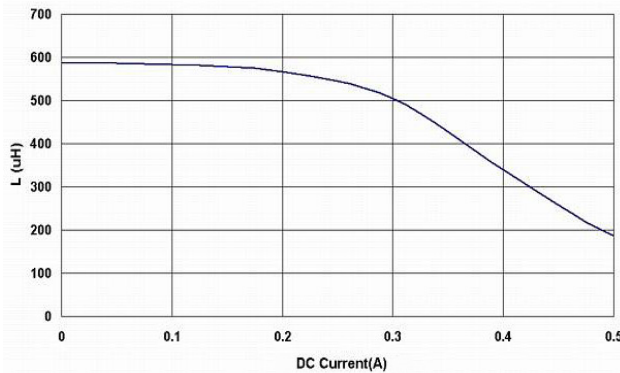

BPSC00070745681□00

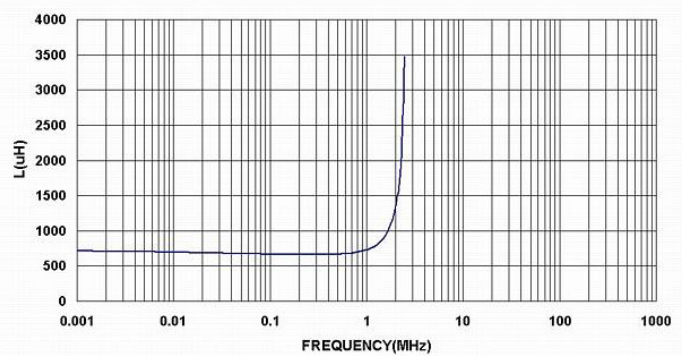
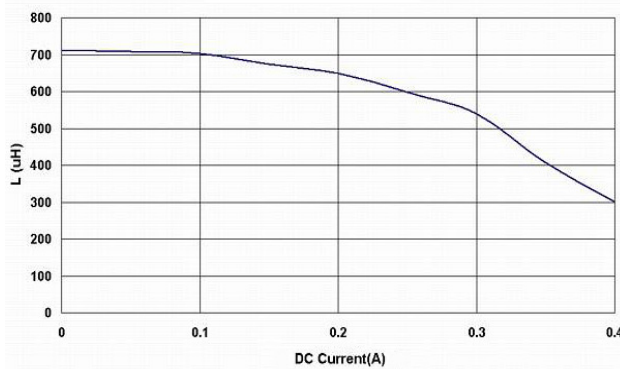

BPSC00070745821□00

