

# Power Inductor



## BMRA Series



### Overview

BMRx series is designed for low profile type with low RDC and ultra large current. Its molded magnetic shielded type is suitable for high-density mounting and ultra low buzz noise. Soldering conditions can be easily confirmed when mounting onto the board. This series also provides customers with embossed carrier type packaging for automatic mounting machine.

### Benefits

1. High rated current
2. Ultra low buzz noise

### Applications

1. DC-DC converters
2. Switchs and servers
3. DC-DC converters, inverters, and battery management systems.
4. Base stations, 5G infrastructure
5. Consumer Electronics: Smartphones, laptops, tablets, wearable devices, and gaming consoles.

### Product Information

Series	L (mm)	W(mm)	T (mm)	Inductance (μH)
BMRA	4.1	4.6	1.2	0.1 ~ 33
	4.1	4.6	1.5	
	4.1	4.6	2.0	
	5.2	5.4	1.2	
	5.4	5.7	1.5	
	5.4	5.7	1.8	
	5.4	5.7	3.0	
	6.6	7.3	1.3	
	6.6	7.3	3.0	



## BMRA00050515 Series Specification

**1 Scope** This specification applies to large current and low loss SMD power inductor.

**2 Part numbering**

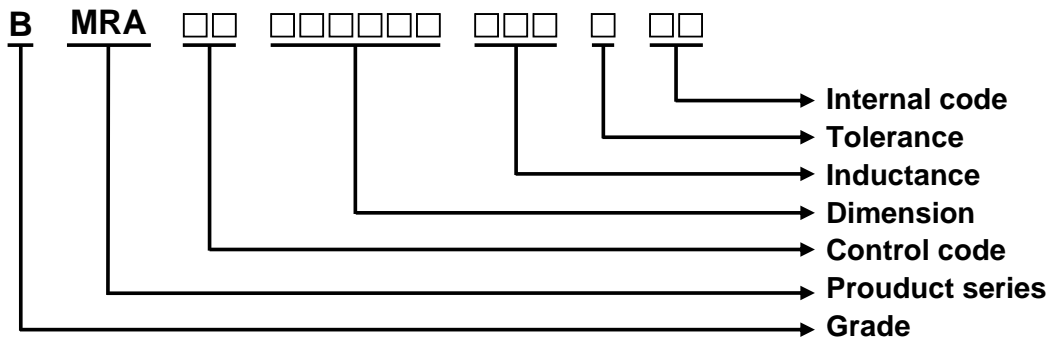

**3 Temperature rating**

Operating Temperature: -55°C to 125°C.

Storage Temperature: (on tape & reel): -20°C to +40°C; 75% RH max.

**4 Marking**

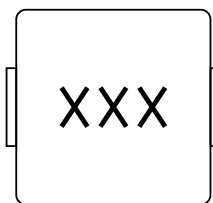

Marking : 1R0

**5 Standard testing condition**

	Unless otherwise specified	In case of doubt
Temperature	Ordinary Temperature(15 to 35°C)	20 to 30°C
Humidity	Ordinary Humidity(25 to 85% RH)	50 to 80 %RH

## BMRA00050515 Series Specification

### 6 Configuration and dimensions

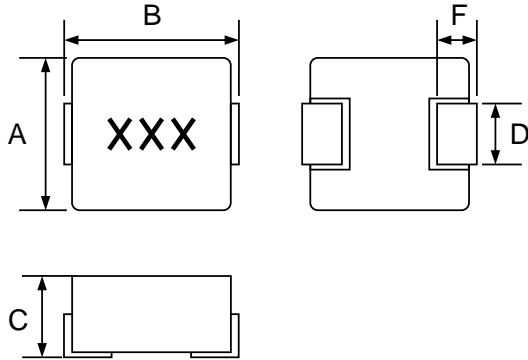

Dimensions in mm

Type	050515
A	5.4 ± 0.35
B	5.7 ± 0.2
C	1.5 Max
D	2.0 ± 0.3
F	1.5 ± 0.3

Size Code	Net weight(grms)
050515	0.22(typ.)

### 7 Electrical characteristics

Part number	Inductance (uH)	Tolerance (±%)	Test Freq.	I <sub>rms</sub> (A) Typ.	I <sub>sat</sub> (A) Typ.	RDC (mΩ) Max.(Typ.)	Marking
BMRA00050515R47MA1	0.47	20	100kHz,0.5V	8	12	16(13)	R47
BMRA00050515R68MA1	0.68	20	100kHz,0.5V	6	10	23(19)	R68
BMRA000505151R0MA1	1	20	100kHz,0.5V	5	8	33(27)	1R0
BMRA000505151R5MA1	1.5	20	100kHz,0.5V	4	6	50(41)	1R5
BMRA000505152R2MA1	2.2	20	100kHz,0.5V	3.3	6	68(57)	2R2
BMRA000505153R3MA1	3.3	20	100kHz,0.5V	3	5	84(70)	3R3
BMRA000505154R7MA1	4.7	20	100kHz,0.5V	2.5	4	135(128)	4R7
BMRA000505155R6MA1	5.6	20	100kHz,0.5V	2.2	3.5	175(146)	5R6
BMRA000505156R8MA1	6.8	20	100kHz,0.5V	2	3	192(160)	6R8
BMRA00050515100MA1	10	20	100kHz,0.5V	1.5	2	195(175)	100

**Note:**

1. Operating temperature range -55°C to 125°C.
2. I<sub>sat</sub> for Inductance drop 30% from its value without current.
3. I<sub>rms</sub> for a 40°C temperature rise from 25°C ambient.
4. The part temperature (ambient + temp rise) should not exceed 125°C under worst case operating conditions. Circuit design 125°C under worst case operating conditions. Component placement, PCB trace size and thickness, airflow and other cooling provisions all affect the part temperature. Part temperature should be verified in the end application.
5. Absolute maximum voltage 30V DC. (Based on test method, it may not the same under different application, it is recommended to verify first.)

## BMRA00050515 Series Specification

### 8 BMRA00050515 Series 8.1 Construction

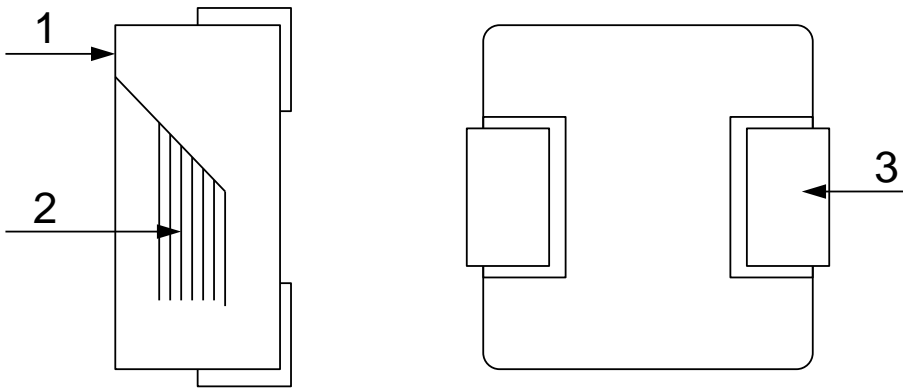

### 8.2 Material List

Item	Part	Description
1	Magnetic core	Magnetic metal powder
2	Coil	Enameled copper wire
3	Terminals	Copper based terminal

## BMRA00050515 Series Specification

### 9 Reliability test items

#### 1-1.Mechanical Performance

No	Item	Specification	Test Method
1-1-1	Vibration	Appearance: No damage Inductance: within $\pm 10\%$ of initial value	Test device shall be soldered on the substrate Oscillation Frequency: 10 to 55 to 10Hz for 1min Amplitude: 1.5mm Time: 2hrs for each axis (X, Y & Z), total 6hrs
1-1-2	Resistance to Soldering Heat	Appearance: No damage	Pre-heating: 150°C, 1min Solder Composition: Sn/Ag3.0/Cu0.5 Solder Temperature: 260 $\pm$ 5°C Immersion Time: 10 $\pm$ 1sec
1-1-3	Solder ability	The electrodes shall be at least 95% covered with new solder coating	Pre-heating: 150°C, 1min Solder Composition: Sn/Ag3.0/Cu0.5 Solder Temperature: 245 $\pm$ 5°C Immersion Time: 4 $\pm$ 1sec
1-1-4	Resistance to solvent	There must be no change in appearance or obliteration of marking.	Inductors must withstand 6 minutes of alcohol or water.

#### 1-2.Environmental Performance

No	Item	Specification	Test Method														
1-2-1	Temperature Shock	Appearance: No damage Inductance: within $\pm 10\%$ of initial value	10 cycles (Air to Air) 1 cycles shall consist of: 30 minutes exposure to -55°C 30 minutes exposure to 125°C 15 seconds maximum transition between temperatures														
1-2-2	Temperature Cycle		One cycle: <table border="1"> <thead> <tr> <th>Step</th> <th>Temperature (°C)</th> <th>Time (min)</th> </tr> </thead> <tbody> <tr> <td>1</td> <td>-55<math>\pm</math>3</td> <td>30</td> </tr> <tr> <td>2</td> <td>25<math>\pm</math>2</td> <td>3</td> </tr> <tr> <td>3</td> <td>125<math>\pm</math>3</td> <td>30</td> </tr> <tr> <td>4</td> <td>25<math>\pm</math>2</td> <td>3</td> </tr> </tbody> </table>	Step	Temperature (°C)	Time (min)	1	-55 $\pm$ 3	30	2	25 $\pm$ 2	3	3	125 $\pm$ 3	30	4	25 $\pm$ 2
Step	Temperature (°C)	Time (min)															
1	-55 $\pm$ 3	30															
2	25 $\pm$ 2	3															
3	125 $\pm$ 3	30															
4	25 $\pm$ 2	3															
1-2-3	Humidity Resistance		Temperature: 40 $\pm$ 2°C Relative Humidity: 90 ~ 95% Time: 1000hrs Measured after exposure in the room condition for 24hrs														
1-2-4	Heat Life		Temperature: 85 $\pm$ 3°C Relative Humidity: 20% Applied Current: Rated Current Time: 1000hrs Measured after exposure in the room condition for 24hrs														
1-2-5	Cold Resistance		Temperature: -55 $\pm$ 3°C Relative Humidity: 0% Time: 1000hrs Measured after exposure in the room condition for 24hrs														

## BMRA00050515 Series Specification

### 10 Recommended IR reflow profile

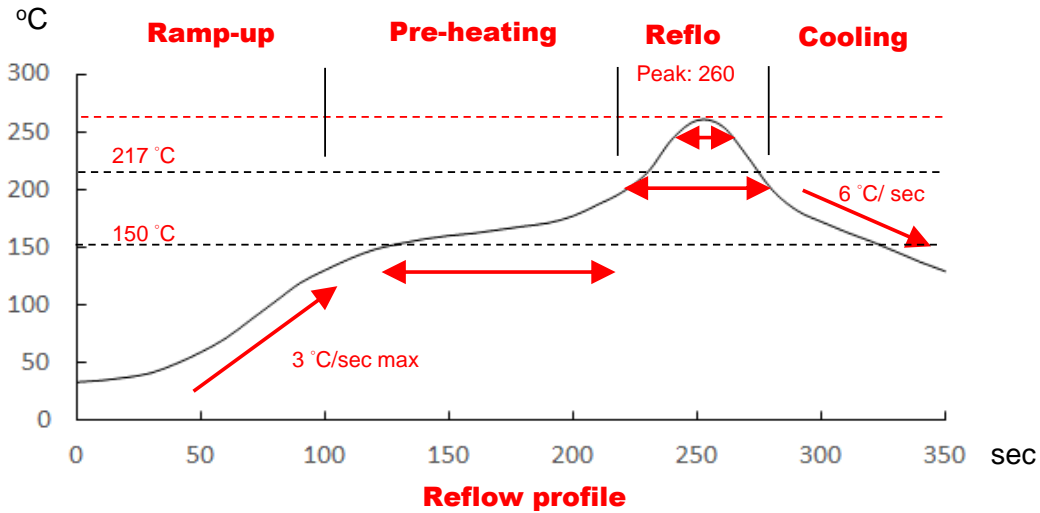

Lead-Free(LF)

Refer to J-STD-020F

Item	Ramp-up	Pre-heating	Reflow	Peak Temp.	Cooling
Temp. scope	R.T. ~150 °C	150 °C~200 °C	217 °C	260±5 °C	Peak Temp. 150 °C
Time spec	-	60~120 sec	60~150 sec	20~40 sec	-

Note:

1. IR reflow times: within 3 times.
2. Nitrogen adopted is recommended while in IR reflow.

## BMRA00050515 Series Specification

### 11 Packaging

#### 11.1 Packaging-cover tape

The force for tearing off cover tape is 10 to 130 grams.

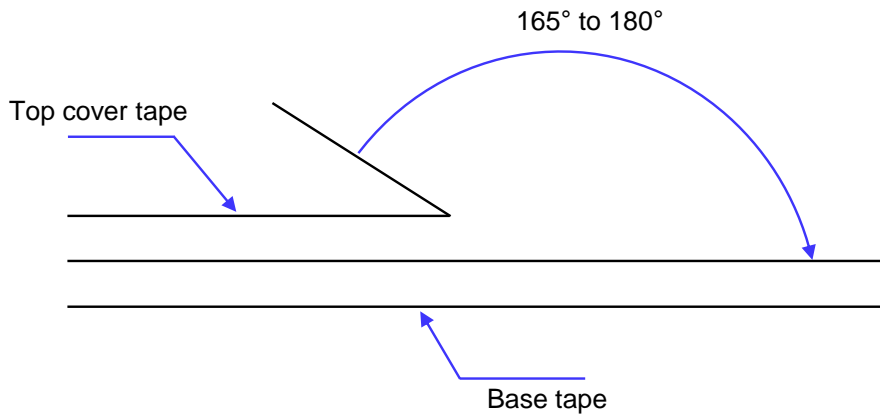

#### 11.2 Packaging quantity

Type	pcs/reel
050515	1000

#### 11.3 Reel dimensions

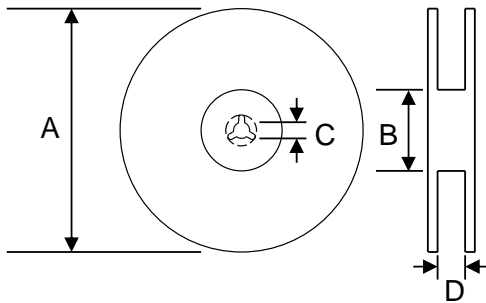

Dimensions in mm

Type	A	B	C	D
050515	330	100	13	16

## BMRA00050515 Series Specification

### 11 Packaging

#### 11.4 Tape dimensions in mm

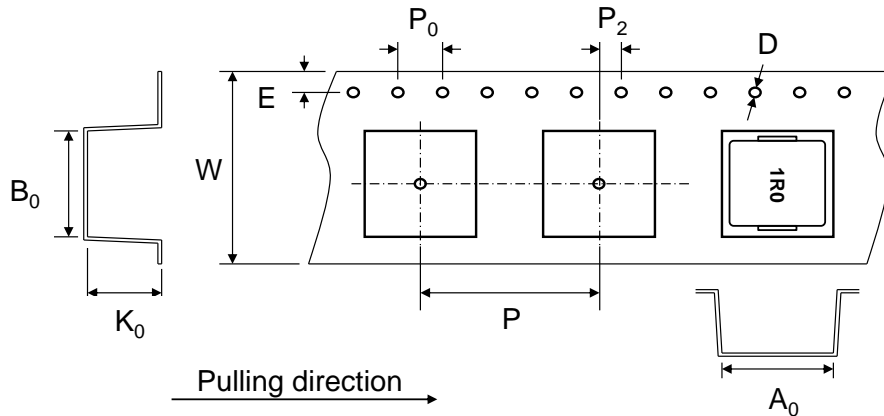

Type	$A_0$	$B_0$	$K_0$	$D$	$E$	$W$	$P$	$P_0$	$P_2$
050515	5.7	6.1	1.9	1.5	1.75	16	12	4	2

### 12 Recommended pattern

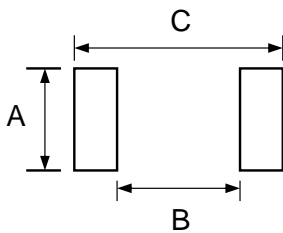

Dimensions in mm

Type	A	B	C
050515	2.5	2.2	6.0

### 13 Note

1. Please make sure that your product has been evaluated and confirmed against your specifications when our product is mounted to your product.
2. Don't design/ mount any components in contact with this product.
3. The moisture sensitivity level (MSL) of products is classified as level 1.
4. Shelf life: 1 years from the date of shipment.

# BMRA00050515 Series Specification

## 14 Graph

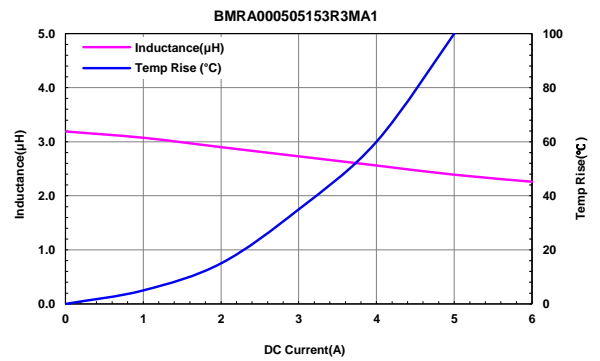
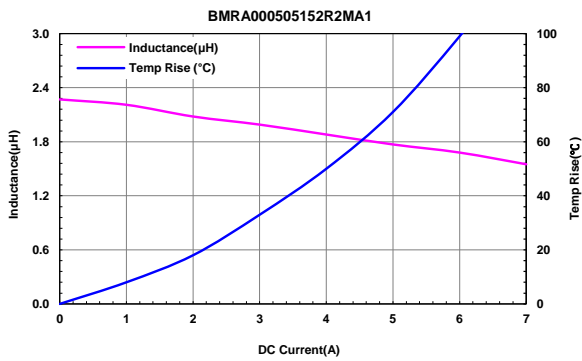
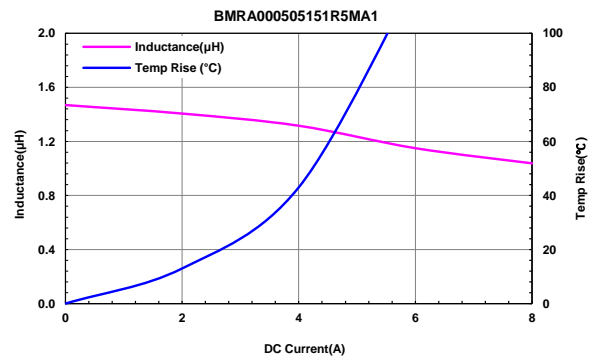
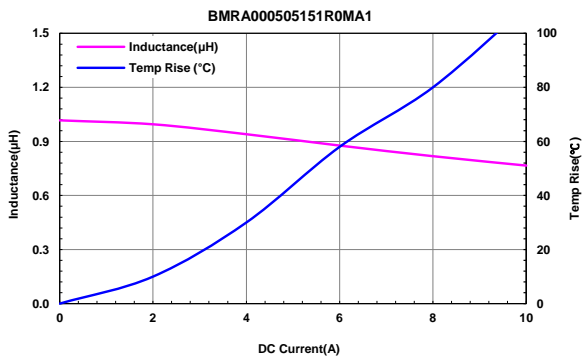
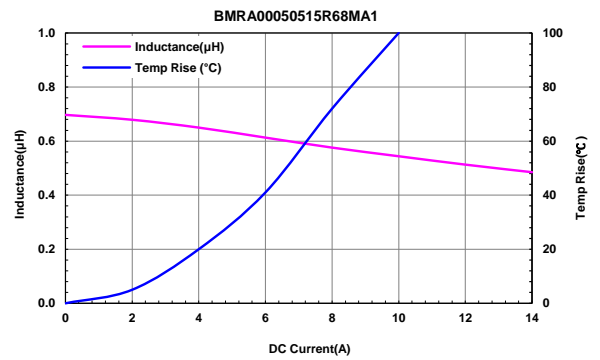
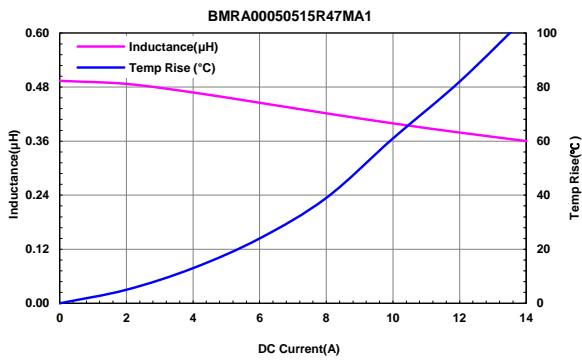

# BMRA00050515 Series Specification

## 14 Graph

