

Power Inductor

BKPE Series



Overview

Power inductors are passive electronic components used in various circuits to store energy in a magnetic field when electrical current flows through them. They are critical in filtering, energy storage, and noise suppression in power electronic systems. They are designed to handle higher currents and are optimized for minimal power loss and thermal efficiency.

Benefits

1. Energy Storage, Efficiently stores and transfers energy in DC-DC converters and power supplies.
2. High Current Handling, Supports high current capacity with minimal losses, ensuring thermal stability.
3. Compact and Efficient Design, Advanced materials and construction enable miniaturization without sacrificing performance, ideal for space-constrained designs.

Applications

1. Consumer Electronics: Smartphones, laptops, tablets, wearable devices, and gaming consoles.
2. Industrial Equipment: Robotics, power tools, industrial automation, and IoT devices.
3. DC-DC converters, inverters, and battery management systems.
4. Base stations, 5G infrastructure, and signal processing systems.

Product Information

Series	L (mm)	W(mm)	T (mm)	Inductance (μH)
BKPE	1.6	0.8	0.8	0.24 ~ 2.2
	1.6	0.8	0.8	
	1.6	0.8	0.6	
	2.0	1.25	1.0	
	2.0	1.6	1.0	
	2.5	2.0	1.0	

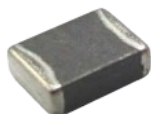

BKPE00201210 Series Specification

1 Scope: This specification applies to Multilayer power inductors

2 Part Numbering:

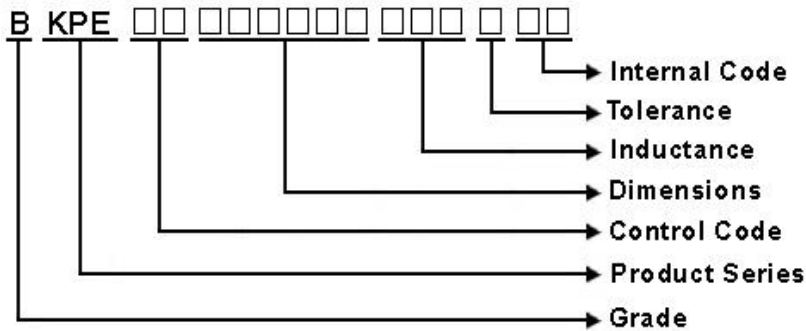

3 Rating:

Operating Temperature: - 5 5 °C ~ 1 2 5 °C(Including self - temperature rise)

Storage Temperature: - 5 5 °C ~ 1 2 5 °C(after PCB)

- 5 °C~4 0 °C, Humidity 4 0 %~7 0 %(before PCB)

4 Marking:

No Marking

5 Standard Testing Condition

	Unless otherwise specified	In case of doubt
Temperature	Ordinary Temperature(15 to 35°C)	20 to 30°C
Humidity	Ordinary Humidity(25 to 85% RH)	50 to 80 %RH

BKPE00201210 Series Specification

6 Configuration and Dimensions:

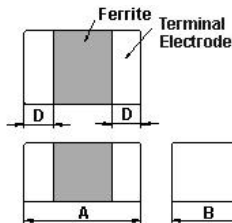

Dimensions in mm	
TYPE	201210
A	2.0±0.2
B	1.25±0.2
C	1.0 Max.
D	0.5±0.3

Net Weight (grms)	
Size Code	Net Weight (grms)
201210	0.0132

7 Electrical Characteristics:

Part No.	Inductance (uH)	Test Freq.	RDC (Ω)±25%	Isat(mA) Max.(Typ)	Irms(mA) Max.(Typ)	Tolerance (±%)
BKPE00201210R24□A2	0.24	3MHz,200mV	0.03	2700(3300)	2200(3200)	20,30
BKPE00201210R47□A2	0.47	3MHz,200mV	0.06	1600(2000)	1800(3000)	20,30
BKPE002012101R0□A2	1	3MHz,200mV	0.1	1400(1700)	1800(2100)	20,30
BKPE002012102R2□A2	2.2	3MHz,200mV	0.125	500(800)	1600(1900)	20,30

NOTE: □-tolerance M=±20% / T=±30%

1. Operating temperature range - 5 5°C ~ 1 2 5°C(Including self - temperature rise)
2. Isat for Inductance drop 30% from its value without current.
3. I rms for a 40°C temperature rise from 25°C ambient with current.

BKPE00201210 Series Specification

8 BKPE00201210 Series

8.1 Construction:

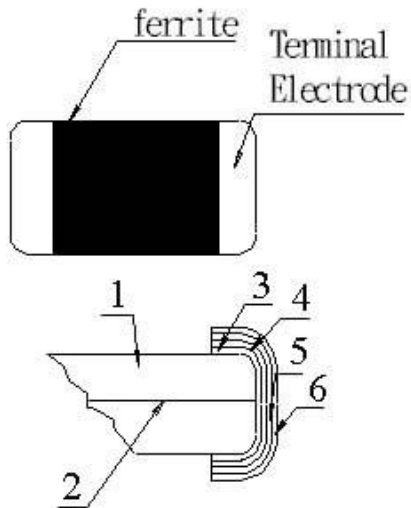

8.2 Material List:

No	Part	Material
1	Ferrite Substance	NiO-CuO-ZnO-Ferrite
2	Silver electrode	Ag
3	Silver electrode	Ag
4	Cu plating	Cu
5	Ni plating	Ni
6	Sn plating	Sn

BKPE00201210 Series Specification

9 Reliability Of Ferrite Multilayer power inductors

1-1.Mechanical Performance

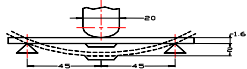
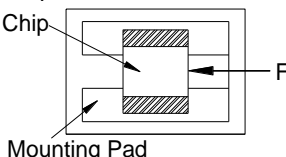
No	Item	Specification	Test Method
1-1-1	Flexure Strength	The forces applied on the right conditions must not damage the terminal electrode and the ferrite	Test device shall be soldered on the substrate Substrate Dimension: 100x40x1.6mm Deflection: 2.0mm Keeping Time: 30sec 
1-1-2	Vibration		
1-1-3	Resistance to Soldering Heat	Appearance: No damage More than 75% of the terminal electrode should be covered with solder. Inductance: within $\pm 20\%$ of initial value	Pre-heating: 150°C, 1min Solder Composition: Sn/Ag3.0/Cu0.5(Pb-Free) Solder Temperature: 260 \pm 5°C Immersion Time: 10 \pm 1sec
1-1-4	Solder ability	The electrodes shall be at least 95% covered with new solder coating	Pre-heating: 150°C, 1min Solder Composition: Sn/Ag3.0/Cu0.5(Pb-Free) Solder Temperature: 245 \pm 5°C Immersion Time: 4 \pm 1sec
1-1-5	Terminal Strength Test	No split termination 	Test device shall be soldered on the substrate, then apply a force in the direction of the arrow. Force : 5N Keeping Time: 10 \pm 1sec

1-2.Environmental Performance

No	Item	Specification	Test Method															
1-2-1	Temperature Cycle	Appearance: No damage Inductance: within $\pm 20\%$ of initial value	One cycle: <table border="1" style="width: 100%; border-collapse: collapse;"> <thead> <tr> <th>Step</th> <th>Temperature (°C)</th> <th>Time (min)</th> </tr> </thead> <tbody> <tr> <td>1</td> <td>-55\pm3</td> <td>30</td> </tr> <tr> <td>2</td> <td>25\pm2</td> <td>3</td> </tr> <tr> <td>3</td> <td>125\pm3</td> <td>30</td> </tr> <tr> <td>4</td> <td>25\pm2</td> <td>3</td> </tr> </tbody> </table>	Step	Temperature (°C)	Time (min)	1	-55 \pm 3	30	2	25 \pm 2	3	3	125 \pm 3	30	4	25 \pm 2	3
			Step	Temperature (°C)	Time (min)													
1	-55 \pm 3	30																
2	25 \pm 2	3																
3	125 \pm 3	30																
4	25 \pm 2	3																
Total: 100cycles Measured after exposure in the room condition for 24hrs																		
1-2-2	Humidity Resistance		Temperature: 40 \pm 2°C Relative Humidity: 90 ~ 95% / Time: 1000hrs Measured after exposure in the room condition for 24hrs															
1-2-3	High Temperature Resistance	Appearance: No damage Inductance: within $\pm 30\%$ of initial value	Temperature: 125 \pm 3°C Relative Humidity: 0% / Time: 1000hrs Measured after exposure in the room condition for 24hrs															
1-2-4	Low Temperature Resistance		Temperature: -55 \pm 3°C Relative Humidity: 0% / Time: 1000hrs Measured after exposure in the room condition for 24hrs															

BKPE00201210 Series Specification

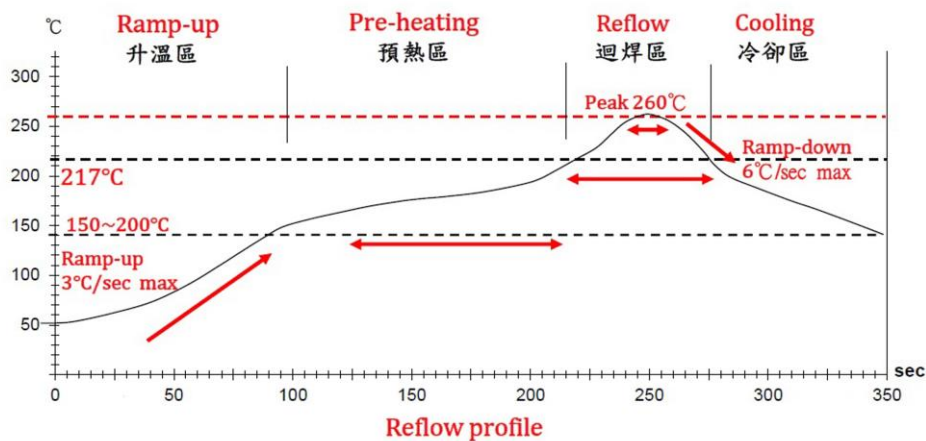

Lead-Free(LF)標準溫度分析範圍

Refer to J-STD-020C

管制項目 Item.	升溫區 Ramp-up	預熱區 Pre-heating	迴焊區 Reflow	Peak Temp	冷卻區 Cooling
溫度範圍 Temp.scope	R.T ~ 150°C	150°C ~ 200°C	Above 217°C	260±5°C	Peak Temp.~150°C
標準時間 Time spec.	-	60 ~ 180 sec	60 ~ 150 sec	20 ~ 40 sec	-
實際時間 Time result	-	75 ~ 100 sec	90 ~ 120 sec	20 ~ 35 sec	-

NOTE :

1. Re-flow possible times : within 2 times
2. Nitrogen adopted is recommended while in re-flow
3. Products can only be soldered with reflow

BKPE00201210 Series Specification

11 Packaging:

11.1 Packaging -Cover Tape

The force for tearing off cover tape is 10 to 100 grams in the arrow direction.

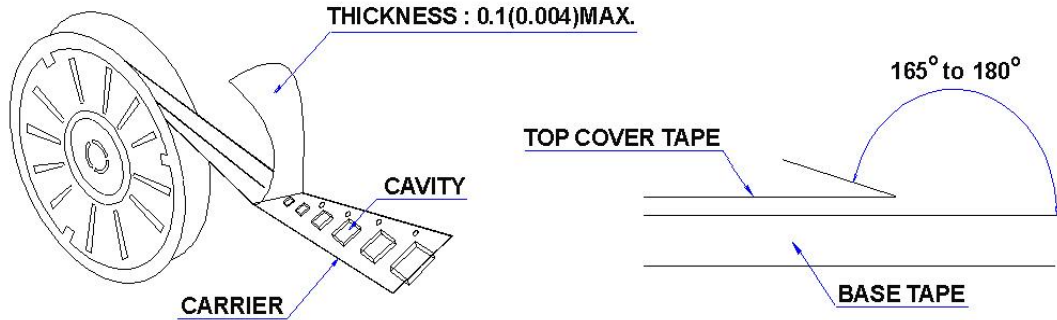

11.2 Packaging Quantity

TYPE	PCS/REEL
201210	3000

11.3 Reel Dimensions

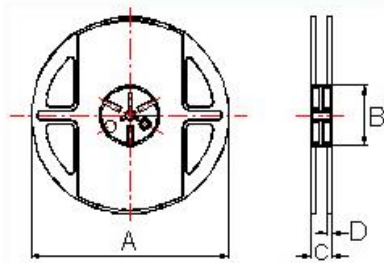

Dimensions in mm

TYPE	A	B	C	D
201210	178	60	12	1.5

BKPE00201210 Series Specification

11 Packaging:

11.4 Tape Dimensions in mm

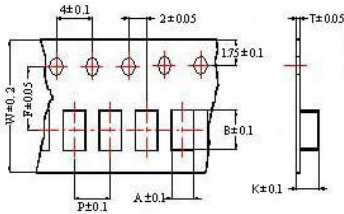

Tape Material

Carrier tape : Polycarbonate

Cover tape : Polyethylene

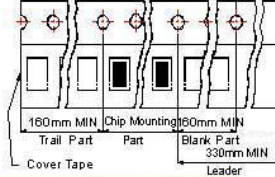

TYPE	A	B	T	W	P	F	K
201210	1.45	2.25	0.22	8	4	3.5	1.04

12 Recommended Land Pattern:

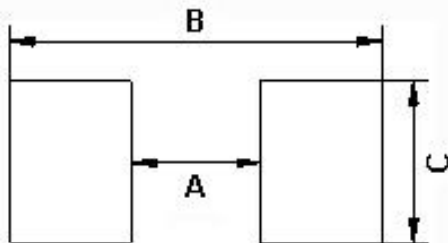

Dimensions in mm

TYPE	A	B	C
201210	0.8~1.2	2.3~2.9	1.0~1.4

13 Note:

1. Please make sure that your product has been evaluated and confirmed against your specifications when our product is mounted to your product.
2. Do not knock nor drop.
3. All the items and parameters in this product specification have been prescribed on the premise that our product is used for the purpose, under the condition and in the environment agreed upon between you and us. You are requested not to use our product deviating from such agreement.
4. Please keep the distance between transformer/coil and other components (refer to the standard IEC 950)
5. The moisture sensitivity level (MSL) of products is classified as level 1.

BKPE00201210 Series Specification

14 Graph:

