

# Power Inductor

## Automotive Grade

### AWVF Series



#### Overview

Power inductors are passive electronic components used in various circuits to store energy in a magnetic field when electrical current flows through them. They are critical in filtering, energy storage, and noise suppression in power electronic systems.

They are designed to handle higher currents and are optimized for minimal power loss and thermal efficiency.

#### Benefits

1. Automotive grade available
2. No thermal aging
3. High current and efficiency, Magnetic epoxy sealing(Seme-shield)

#### Applications

1. Automotive Systems for Infotainment, MCU, Dashboard, CCD Module
2. Media player, Audio class
3. Net working, LCD Panel/TV,
4. Base stations, 5G infrastructure, and signal processing systems.
5. Telematics

#### Product Information

| Series | L (mm) | W(mm) | T (mm)  | Inductance (μH) |
|--------|--------|-------|---------|-----------------|
| AWVF   | 2.0    | 1.6   | 1.2     | 0.24 ~ 330      |
|        | 2.5    | 2.0   | 1.02    |                 |
|        | 2.5    | 2.0   | 1.2     |                 |
|        | 3.0    | 3.0   | 1.02    |                 |
|        | 3.0    | 3.0   | 1.2     |                 |
|        | 3.0    | 3.0   | 1.5     |                 |
|        | 3.0    | 3.0   | 1.5     |                 |
|        | 4.0    | 4.0   | 1.2     |                 |
|        | 4.0    | 4.0   | 1.5     |                 |
|        | 4.0    | 4.0   | 1.9     |                 |
|        | 4.0    | 4.0   | 2.6     |                 |
|        | 5.0    | 5.0   | 2.0     |                 |
|        | 6.0    | 6.0   | 2.0     |                 |
|        | 6.0    | 6.0   | 2.8     |                 |
|        | 8.0    | 8.0   | 3.7~4.2 |                 |



# AWVF00404026 Series Specification

AEC-Q200

**1 Scope:** This specification applies to Wire Wound Power Inductors

**2 Part Numbering:**

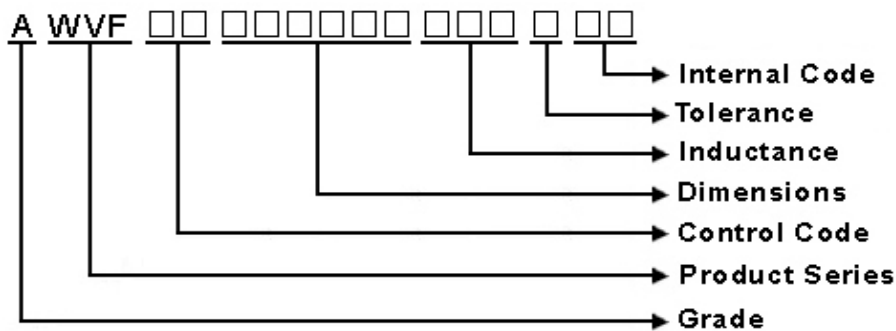

**3 Rating:**

Operating Temperature: - 4 0 °C ~ 1 2 5 °C(Including self - temperature rise)

Storage Temperature: - 4 0 °C ~ 1 2 5 °C

(The storage temperature range is for after the assembly)

**4 Marking:**

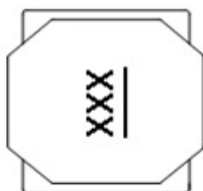

**Ex Marking : 100**

**Marking color : Black**

**5 Standard Testing Condition**

|             | Unless otherwise specified       | In case of doubt |
|-------------|----------------------------------|------------------|
| Temperature | Ordinary Temperature(15 to 35°C) | 20 to 30°C       |
| Humidity    | Ordinary Humidity(25 to 85% RH)  | 50 to 80 %RH     |

# AWVF00404026 Series Specification

AEC-Q200

## 6 Configuration and Dimensions:

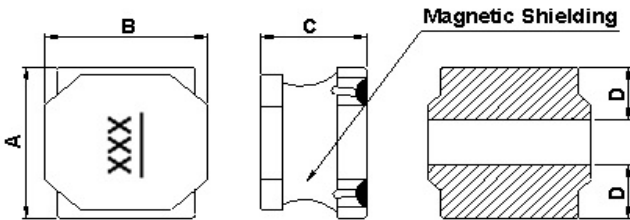

Dimensions in mm

| TYPE | 404026   |
|------|----------|
| A    | 4.0±0.2  |
| B    | 4.0±0.2  |
| C    | 2.6±0.2  |
| D    | 1.4 typ. |

Net Weight (grms)

| SIZE CODE | Net Weight (grms) |
|-----------|-------------------|
| 404026    | 0.16145 (typ).    |

## 7 Electrical Characteristics:

| Part No.           | Inductance (uH) | Test Freq. | RDC (mΩ)±30% | Isat(A) Typ.(Max) | Irms(A) Typ.(Max) | Tolerance (±%) | Marking |
|--------------------|-----------------|------------|--------------|-------------------|-------------------|----------------|---------|
| AWVF004040261R0□00 | 1.0             | 100kHz,1V  | 30           | 5.00(4.50)        | 4.00(3.60)        | 20,30          | 1R0     |
| AWVF004040261R5□00 | 1.5             | 100kHz,1V  | 35           | 4.20(3.70)        | 3.70(3.30)        | 20,30          | 1R5     |
| AWVF004040262R2□00 | 2.2             | 100kHz,1V  | 45           | 3.80(3.40)        | 3.50(3.10)        | 20,30          | 2R2     |
| AWVF004040263R3□00 | 3.3             | 100kHz,1V  | 67           | 3.00(2.70)        | 2.50(2.20)        | 20,30          | 3R3     |
| AWVF004040264R7□00 | 4.7             | 100kHz,1V  | 92           | 2.60(2.30)        | 2.00(1.80)        | 20,30          | 4R7     |
| AWVF004040265R6□00 | 5.6             | 100kHz,1V  | 110          | 2.30(2.00)        | 1.90(1.70)        | 20,30          | 5R6     |
| AWVF004040266R8□00 | 6.8             | 100kHz,1V  | 130          | 2.00(1.80)        | 1.70(1.50)        | 20,30          | 6R8     |
| AWVF00404026100□00 | 10              | 100kHz,1V  | 188          | 1.90(1.70)        | 1.40(1.20)        | 20,30          | 100     |
| AWVF00404026150□00 | 15              | 100kHz,1V  | 240          | 1.40(1.30)        | 1.20(1.00)        | 20,30          | 150     |
| AWVF00404026220□00 | 22              | 100kHz,1V  | 330          | 1.20(1.00)        | 1.00(0.90)        | 20,30          | 220     |
| AWVF00404026330□00 | 33              | 100kHz,1V  | 480          | 1.00(0.90)        | 0.82(0.73)        | 20,30          | 330     |
| AWVF00404026470□00 | 47              | 100kHz,1V  | 735          | 0.88(0.79)        | 0.64(0.57)        | 20,30          | 470     |
| AWVF00404026101□00 | 100             | 100kHz,1V  | 1380         | 0.58(0.52)        | 0.50(0.45)        | 20,30          | 101     |
| AWVF00404026151□00 | 150             | 100kHz,1V  | 2500         | 0.50(0.45)        | 0.38(0.34)        | 20,30          | 151     |
| AWVF00404026271□00 | 270             | 100kHz,1V  | 4400         | 0.34(0.30)        | 0.27(0.24)        | 20,30          | 271     |
| AWVF00404026331□00 | 330             | 100kHz,1V  | 4600         | 0.31(0.27)        | 0.25(0.22)        | 20,30          | 331     |

**NOTE:** □-tolerance M=±20% / T=±30%

1. Operating temperature range - 4 0°C ~ 1 2 5°C(Including self - temperature rise)
2. Isat for Inductance drop 30% from its value without current.
3. Irms for a 40°C temperature rise from 25°C ambient.

**8 AWVF00404026 Series**

**8.1 Construction:**

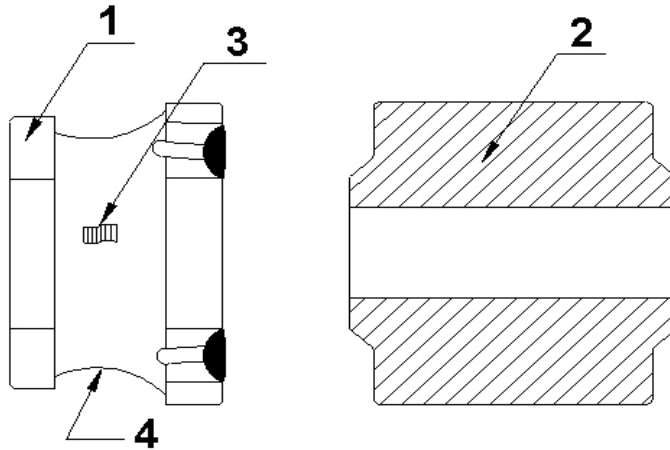

**8.2 Material List:**

| NO | Part     | Material              |
|----|----------|-----------------------|
| 1  | Core     | Ferrite               |
| 2  | Terminal | Ag/Ni/Sn              |
| 3  | Wire     | Copper(180°C)         |
| 4  | Epoxy    | Magnetic powder resin |

## AWVF00404026 Series Specification

AEC-Q200

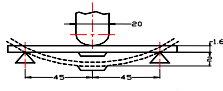
| <b>9 Reliability of Wire Wound Power Inductors</b> |                                     |   |  |
|--|-------------------------------------|---|--|
| <b>1-1.Mechanical Performance</b>                  |                                     |   |  |
|  | <b>Item</b>                         | <b>Specification</b>  | <b>Test Method</b>   |
| 1-1-1  | Board Flex                          | The forces applied on the right conditions must not damage the terminal electrode and the ferrite.  | Test device shall be soldered on the substrate<br>Substrate Dimension: 100x40x1.6mm<br>Deflection: 2.0mm<br>Keeping Time: 60 sec<br>   |
| 1-1-2  | Terminal Strength                   | The chip must not damage the terminal electrode and the ferrite.                                    | Appendix 1 Note(AEC-Q200-005):Force of 1.8 kg for 60 seconds.  |
| 1-1-3  | Solderability                       | The electrodes shall be at least 95% covered with new solder coating.                               | Pre-heating: 150℃, 1min<br>Solder Composition: Sn/3.0Ag/0.5Cu<br>Solder Temperature: 245±5℃<br>Immersion Time: 4±1sec  |
| 1-1-4  | Resistance to Soldering Heat        | Appearance:No damage<br>Inductance change shall be within ±10%.                                     | Pre-heating: 150℃, 1min<br>Solder Composition: Sn/Ag3.0/Cu0.5<br>Solder Temperature: 260±5℃<br>Immersion Time: 10±1sec   |
| 1-1-5  | Resistance to Solvents              | There must be no change in appearance or obliteration of marking.                                   | Inductors must withstand 6 minutes of alcohol or water.  |
| 1-1-6  | Mechanical Shock                    | The forces applied on the right conditions must not damage the terminal electrode and the ferrite.  | Pulse shape : Half-sine waveform<br>Impact acceleration : 100 g<br>Pulse duration : 6 ms<br>Number of shocks : 18 shocks (3 shocks for each face)<br>Orientation : Bottom, top, left, right, front and rear faces  |
| 1-1-7  | Vibration                           | Appearance:No damage<br>Inductance change shall be within ±10%.                                     | Vibration waveform: Sine waveform<br>Vibration frequency: 10Hz~2000Hz<br>Vibration acceleration: 5g<br>Sweep rate: 0.764386octave/minute<br>Duration of test: 12 cycles each of 3 orientations<br>20 minutes for each cycle<br>Vibration axes: X, Y & Z  |
| <b>1-2.Environmental Performance</b>               |                                     |   |  |
| No   | Item                                | Specification   | Test Method  |
| 1-2-1  | High Temperature Exposure (Storage) | Appearance:No damage (for microscope of CASTOR MZ-4 20X)<br>Inductance change shall be within ±10%. | Temperature: 125±3℃<br>Time: 1000hrs<br>Measured after exposure in the room condition for 24hrs  |
| 1-2-2  | Operational Life                    |   | Temperature: 125±2℃<br>Applied Current : Rated Current<br>Time: 1000± 24 hrs<br>Measured after exposure in the room condition for 24hrs  |
| 1-2-3  | Biased Humidity                     |   | Temperature: 85±2℃<br>Relative Humidity: 85%<br>Time: 1000hrs<br>Measured after exposure in the room condition for 24hrs   |
| 1-2-4  | Temperature Cycling                 |   | Total cycles: 1000 cycles<br>Temperature Cycling Test Conditions : -40 to +125 ℃<br>Soak Mode Condition : 30 minutes<br>Measured after exposure in the room condition for 24hrs  |
| 1-2-5  | ESD                                 |   | Test mode : Contact Discharge<br>Discharge level : ±6KV, Discharge interval : 1 second<br>Polarity of the output voltage : Positive and negative<br>Number of discharge : Discharge +/- for 1 time for the 2 test points.<br>Test Mode : Air Discharge<br>Discharge level : ±12KV, ±16KV, ±25KV<br>Discharge interval : < 5 seconds<br>Polarity of the output voltage : Positive and negative<br>Number of discharge : Discharge +/- for 1 time for the 1~2 test points. |



Lead-Free(LF)標準溫度分析範圍

Refer to J-STD-020C

| 管制項目<br>Item.       | 升温區<br>Ramp-up | 預熱區<br>Pre-heating | 迴焊區<br>Reflow | Peak Temp   | 冷卻區<br>Cooling   |
|---------------------|----------------|--------------------|---------------|-------------|------------------|
| 溫度範圍<br>Temp.scope  | R.T ~ 150°C    | 150°C ~ 200°C      | Above 217°C   | 260±5°C     | Peak Temp.~150°C |
| 標準時間<br>Time spec.  | -              | 60 ~ 180 sec       | 60 ~ 150 sec  | 20 ~ 40 sec | -                |
| 實際時間<br>Time result | -              | 75 ~ 100 sec       | 90 ~ 120 sec  | 20 ~ 35 sec | -                |

NOTE :

1. Re-flow possible times : within 2 times
2. Nitrogen adopted is recommended while in re-flow
3. Products can only be soldered with reflow

**10 Packaging:**

**10.1 Packaging -Cover tape**

The force for tearing off cover tape is 10 to 130 grams in the arrow direction.

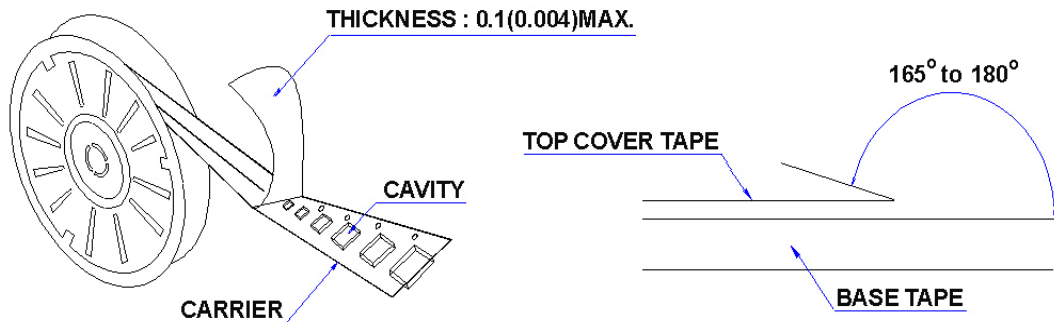

**10.2 Packaging Quantity**

| TYPE   | PCS/REEL |
|--------|----------|
| 404026 | 500      |

**10.3 Reel Dimensions**

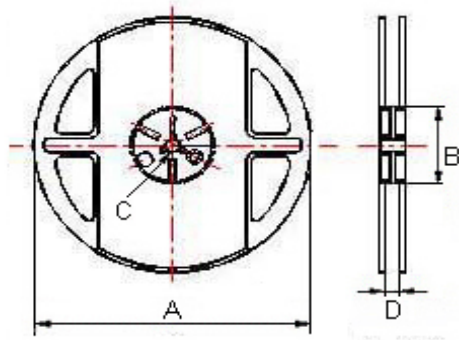

Dimensions in mm

| TYPE   | A   | B  | C  | D    |
|--------|-----|----|----|------|
| 404026 | 178 | 60 | 13 | 13.2 |

**10 Packaging:**

**10.4 Tape Dimensions in mm**

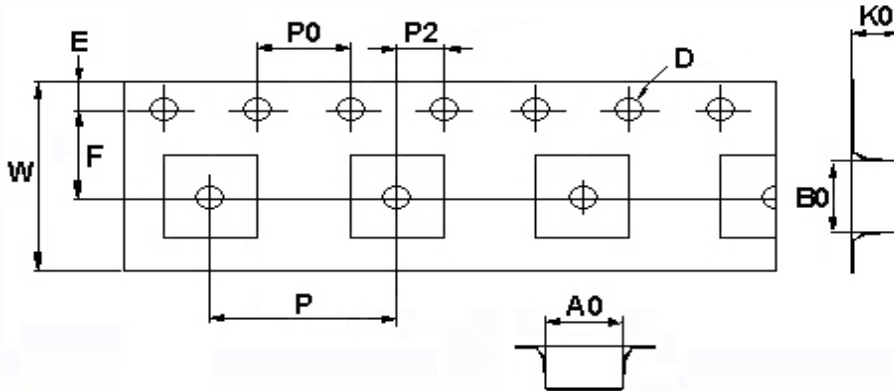

| TYPE   | A0   | B0   | K0  | D    | E    | F   | W  | P | P0 | P2 |
|--------|------|------|-----|------|------|-----|----|---|----|----|
| 404026 | 4.25 | 4.25 | 3.0 | 1.55 | 1.75 | 5.5 | 12 | 8 | 4  | 2  |

**11 Recommended Land Pattern:**

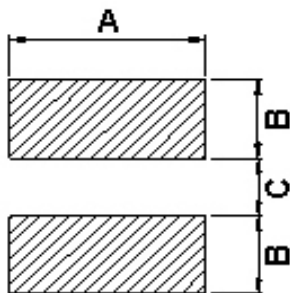

Dimensions in mm

| TYPE   | A   | B   | C   |
|--------|-----|-----|-----|
| 404026 | 3.7 | 1.6 | 1.2 |

**12 Note:**

1. Please make sure that your product has been evaluated and confirmed against your specifications when our product is mounted to your product.
2. Do not knock nor drop.
3. All the items and parameters in this product specification have been prescribed on the premise that our product is used for the purpose, under the condition and in the environment agreed upon between you and us. You are requested not to use our product deviating from such agreement.
4. The storage period is less than 12 months. Be sure to follow the storage conditions (Temperature: 5 to 40°C, Humidity: 10 to 75% RH or less).  
If the storage period elapses, the soldering of the terminal electrodes may deteriorate.
5. Do not use or store in locations where there are conditions such as gas corrosion (salt, acid, alkali, etc.).
6. The moisture sensitivity level (MSL) of products is classified as level 1.

**12** Note:

7. Void Appearance tolerance Limit

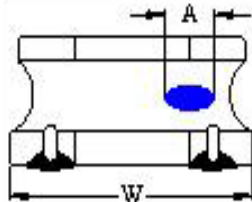

**Exposed wire tolerance limit of coating resin part on product side.**  
The unilateral should be no more than two holes.

$A \leq W/2$  GOOD  
 $A > W/2$  NG

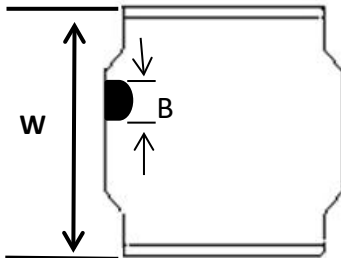

**The appearance standard of the chipping size in top side.**

$B \leq W/8$  GOOD  
 $B > W/8$  NG

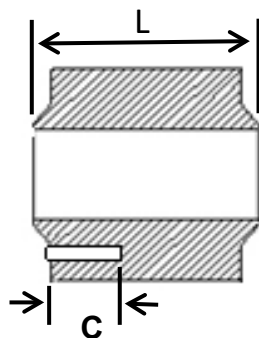

**Electrode appearance criterion for exposed wire.**

$C \leq L/4$  GOOD  
 $C > L/4$  NG

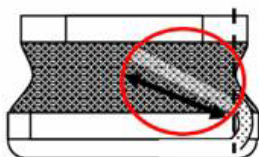

**External appearance criterion for exposed wire**

Exposed end of the winding wire at the side should be acceptable.

**13** Graph: AWVF00404026 Series Graph

AWVF004040261R0=00

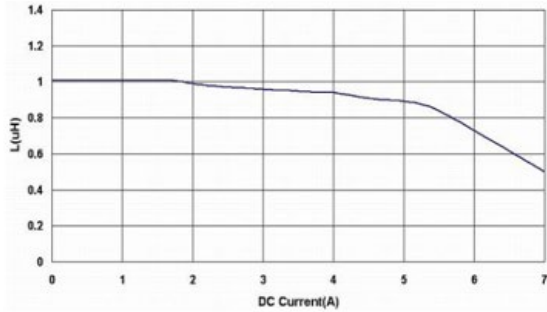

AWVF004040261R0=00

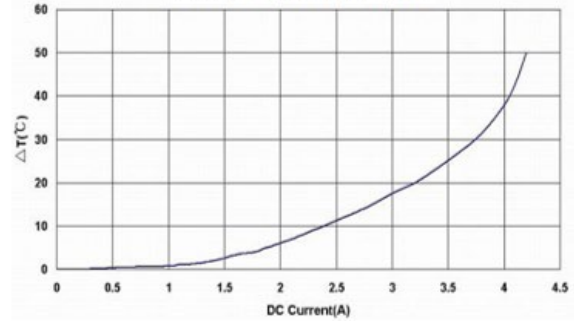

AWVF004040261R5=00

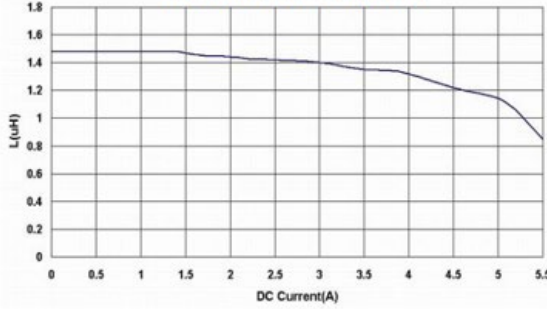

AWVF004040261R5=00

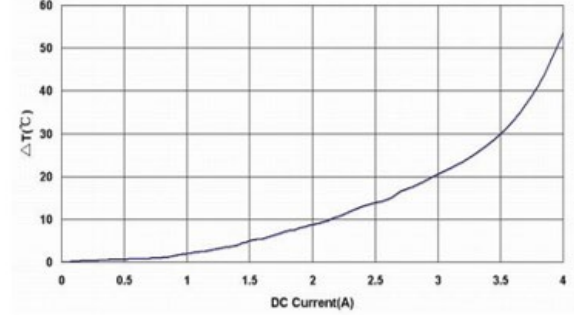

AWVF004040262R2=00

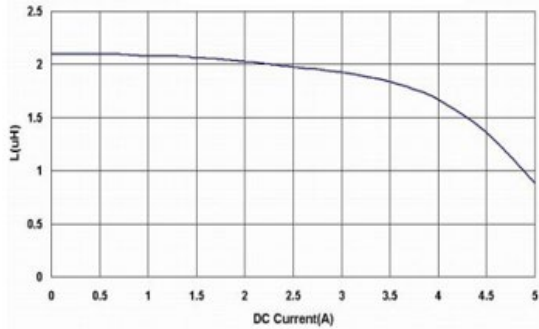

AWVF004040262R2=00

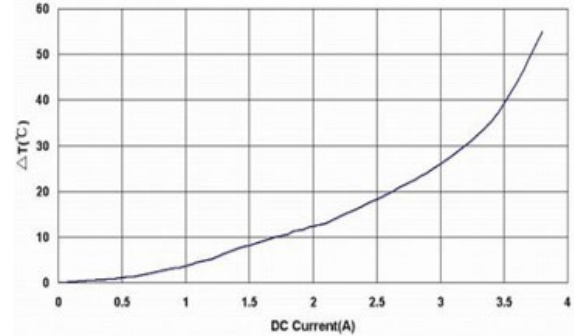

AWVF004040263R3=00

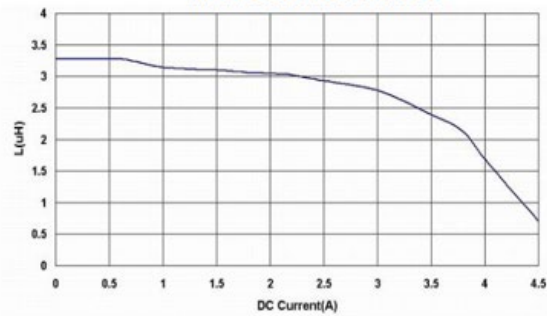

AWVF004040263R3=00

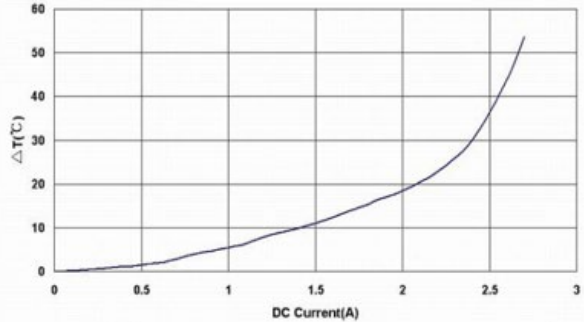

# AWVF00404026 Series Specification

AEC-Q200

AWVF004040264R7=00

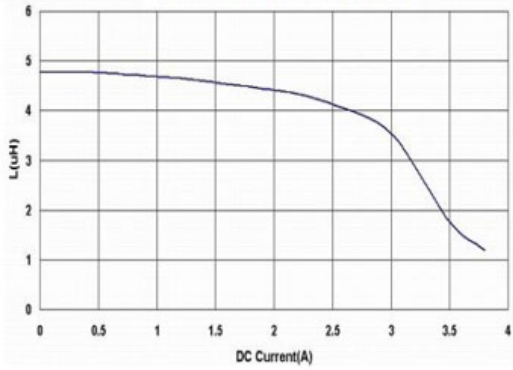

AWVF004040264R7=00

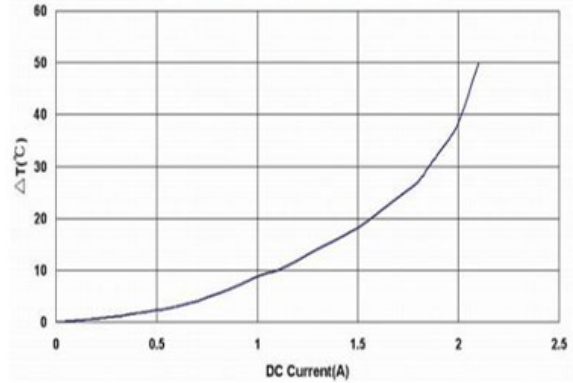

AWVF004040265R6=00

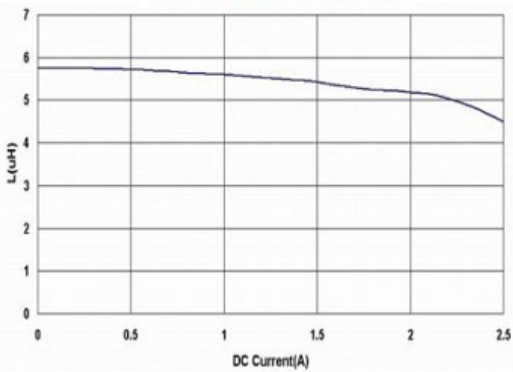

AWVF004040265R6=00

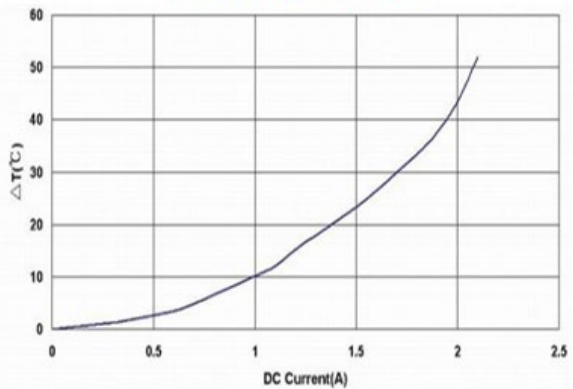

AWVF004040266R8=00

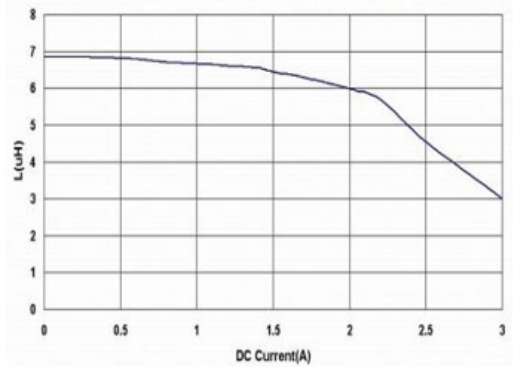

AWVF004040266R8=00

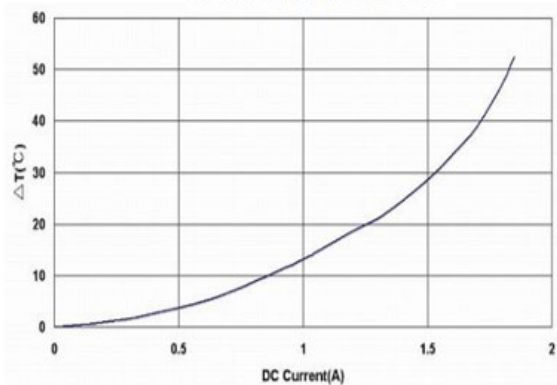

AWVF00404026100=00

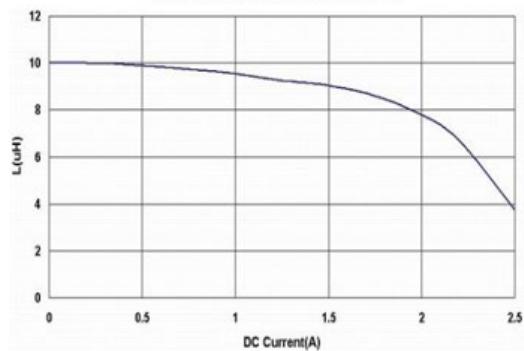

AWVF00404026100=00

